

## VEG110 - DEC 21, 2018

Item # VEG110 was discontinued on December 21, 2018. For informational purposes, this is a copy of the website content at that time and is valid only for the stated product.

### Vega Series Swept Source OCT Imaging System

Deep Imaging at High Speed



**LASER RADIATION**  
DO NOT VIEW DIRECTLY WITH  
OPTICAL INSTRUMENTS  
CLASS 1M LASER PRODUCT

#### OVERVIEW

##### Features

- Configurable OCT System Optimized for High-Speed Imaging with Deep Penetration
  - 12 mm Imaging Depth with 16  $\mu\text{m}$  Axial Resolution in Air
  - 1300 nm Center Wavelength
- 101 dB Sensitivity at 100 kHz Scan Rate
- Includes Computer and ThorImage<sup>®</sup>OCT Software Package (See the *Software* Tab)
- Build-Your-Own and Preconfigured Systems Available
- See the *Brochures* Tab for More Information on Thorlabs' OCT Systems



OCT Applications Team Based in Lübeck, Germany

We're Happy to Assist!

[Contact Us](#)

##### Exploring the Options?

We can provide recommendations based on your needs and partner with you to obtain images of samples provided by you demonstrating the effects of various components on image quality. Demos of our OCT systems can be arranged at our Sterling, VA (USA); Shanghai, China; Tokyo, Japan; and Lübeck, Germany facilities.

##### In the Budgetary Phase?

System prices vary based on the exact components. Through our conversations, we can ensure your system quote is tailored to your requirements.

##### OEM or Custom Projects?

[Click here to learn about our OEM capabilities.](#)

##### Choose Components to Build or Customize Your OCT System

- High-Speed and Long-Range 1300 nm Base Unit
- Standard, User-Customizable, and/or Handheld Beam Scanning System
- Scan Lens Kits to Optimize Lateral Resolution and Focal Length for Your Application
- Ring- and Immersion-Style Sample Z-Spacers for Air or Liquid Imaging Applications
- Scanner Stand and Translation Stage Accessories
- Contact Our OCT Team to Request a Quote and Discuss Building a System

Optical Coherence Tomography (OCT) is a noninvasive optical imaging technique that produces real-time, 2D cross-sectional and 3D volumetric images of a sample. This technique provides structural information about the sample based on light backscattered from different layers of material within that sample, producing images with micron-level resolution and millimeters of imaging depth. OCT imaging can be considered as an optical analog to ultrasound imaging that achieves higher resolution at the cost of decreased penetration depth. In addition to high resolution, the non-contact, noninvasive nature of OCT makes it well suited for imaging samples such as biological tissue, small animals, and industrial materials.

Thorlabs' Vega Series 1300 nm OCT Imaging Systems provide the flexibility required for long-range and high-speed imaging applications. Each of Thorlabs' OCT systems includes a computer with ThorImageOCT 64-bit software installed. The software displays and processes 2D and 3D OCT data in real time.

There are two options for selecting a Vega Series OCT system: choosing the complete, preconfigured VEG110C1 system that consists of components pre-selected from this page, or choosing an OCT system optimized for your specific application. When the popular last option is taken, the Vega OCT system is configured from individual components on this page. We invite you to contact us to assist in identifying the best options for your application. Each Vega OCT system includes, at a minimum, the VEG110 Base Unit, a beam scanning system, and a scan lens kit. Scanner options including a robust standard scanner, user-customizable scanner, and the portable handheld scanner. A selection of scan lens kits provide the flexibility to tailor imaging resolution or working



[Application Articles](#)

distance. Optional accessories, also available below, further customize your OCT system to meet the requirements of your application.

The components available below can also be used to upgrade your existing Thorlabs OCT system with additional features and are fully compatible out of the box with Thorlabs' OCT systems and accessories. While most systems are upgradable, we recommend contacting the OCT Team to determine the optimal solution for your system and intended application.

**Click on the Image Below or in the Table to the Right for Details on Customization Options**



Vega Customization Options
OCT Base Unit (Computer Included)
Scanning System
Scan Lens Kit
Sample Z-Spacer (Not Shown)
Adjustable Scanner Stand
Translation Stage
Preconfigured Systems (Z-Spacer Not Included)

## SOFTWARE

### ThorImage® OCT Software Index

- Introduction
- Imaging Modes
  - 1D Mode for Single Point Measurements
  - 2D Mode for Cross-Sectional Imaging
  - 3D Mode for Volume Imaging
  - Doppler Mode for Doppler Flow Imaging
  - Speckle Variance Mode for Angiographic Imaging
- Externally-Triggered Acquisition for Synchronized Measurements
- Easy Probe Calibration for Different Configurations
- Video Showing Screencast of Rendering Capabilities

### ThorImageOCT Software

- Interactive Scan Position Control through Video Display for Common Line Scans or Freeform Pattern Scans
- Advanced Dataset Management
- Access to Raw Spectra, Processed Data, and All Calibration Files Necessary for User-Designed Processing Routines
- High-Speed Volume Rendering of 3D Data
- Doppler and Speckle Variance Imaging
- Versatile Scan and Acquisition Control, such as Averaging or Adjustable Scan Speeds

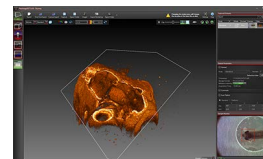

Click to Enlarge  
Rendered Volume with Modifiable Clipping Plane of a Zebrafish

ThorImageOCT is a high-performance data acquisition software, which is included with all Thorlabs OCT systems. This 64-bit Windows-based software package performs data acquisition, processing, scan control, and displays OCT images. Additionally, NI LabVIEW and C-based Software Development Kits (SDKs) are available, which contain a complete set of libraries for measurement control, data acquisition and processing, as well as storage and display of OCT images. The SDKs provide the means for developing highly specialized OCT imaging software for every individual application.

### Scan Control

ThorImageOCT provides numerous scan and acquisition controls. The camera integrated in the scanner of our OCT systems provides live video images in the application software. Defining the scan line for 2D imaging or the scan area for 3D imaging is accomplished through the easy-to-use "Draw and Scan" feature by clicking on

the video image.

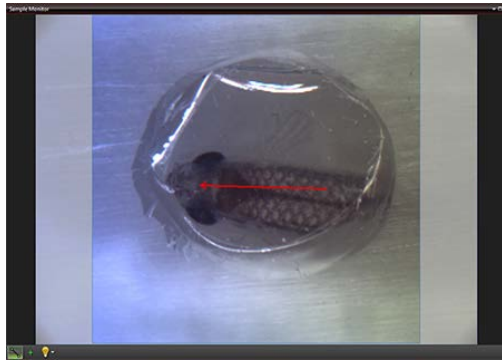

Click to Enlarge

The Sample Monitor can be used to define the scan pattern using the "Draw and Scan" feature.

With version 5.0, a new freeform scan pattern feature has been implemented. Arbitrary forms defined by the Draw & Scan feature or loaded .txt files can be scanned. The scan pattern can also be adjusted by specifying suitable parameters in the controls of the software, as shown to the right.

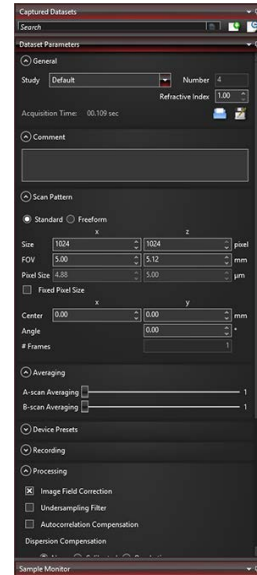

Click to Enlarge

Various acquisition parameters can be adjusted in ThorImageOCT.

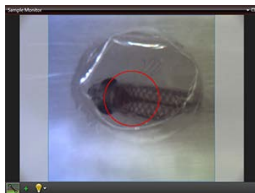

Click to Enlarge

A predefined circle scan pattern can be loaded and scanned in the software. The size can be changed with the Zoom feature.

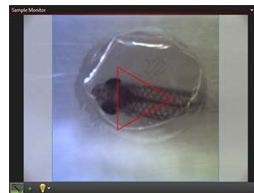

Click to Enlarge

A predefined triangle scan pattern can be loaded and scanned in the software. The size can be changed with the Zoom feature.

Additionally, one can further set processing parameters, averaging parameters, and the speed and sensitivity of the device using device presets. By using a high-speed preset, video-like frame rates in 2D and fast volume rendering in 3D are possible, whereas high-sensitivity acquisition is enabled by choosing a preset with a lower acquisition speed.

## Dataset Management

ThorImageOCT provides advanced dataset management capabilities, which allow opening several datasets simultaneously. Datasets are uniquely defined using an identifier consisting of a study (or test series) name and an experiment number. Grouping of datasets can be achieved by using the same study name. The "Captured Datasets" list shows an overview of all open datasets, including the dataset identifier, the acquisition mode, and preview pictures of the still video image and the OCT data.

Datasets can be exported in various image formats, such as PNG, BMP, JPEG, PDF, or TIFF. The set can also be exported in complete data formats suited for post-processing purposes, such as RAW/SRM, FITS, VTK, VFF, and 32-bit floating-point TIFF.

The OCT file format native to ThorImageOCT allows OCT data, sample monitor data, and all relevant metadata to be stored in a single file. ThorImageOCT can also be installed and run on computers without OCT devices in order to view and export OCT data. The user has full access to the raw and processed data from the device, including additional data used for processing, e.g. offset errors.

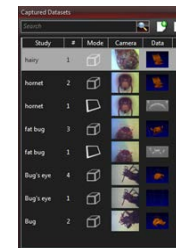

Click to Enlarge  
The Dataset Management Window of ThorImageOCT

## Third Party Applications

If both ImageJ and ThorImageOCT are installed on the computer, opening acquired OCT data in ImageJ is one mouse click away. This enables a flawless workflow when requiring the advanced image processing functionality provided by ImageJ. Clicking the Explorer button will open the folder and select the file in Windows Explorer where the currently active dataset is stored.

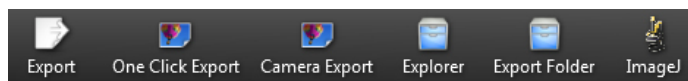

Export buttons are accessible in the Action Toolbar of ThorImageOCT.

## Imaging Modes

Different OCT imaging modes can be selected using the mode selector. If the ThorImageOCT software finds a compatible system connected and switched on, all operational modes will be selectable. If no OCT device is present, only the data viewing mode for viewing and exporting OCT data will be available.

### 1D Mode

The 1D Mode provides the possibility to

measure at a single point. The single point measurement not only provides spectral information and depth information, but also gives the possibility to observe time related behavior of a sample with an M-Scan.

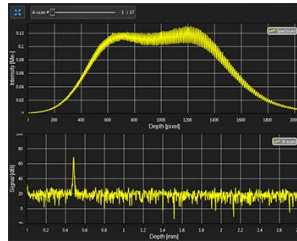

Click to Enlarge  
Spectral and Depth Information for a Single Point (A-Scan)

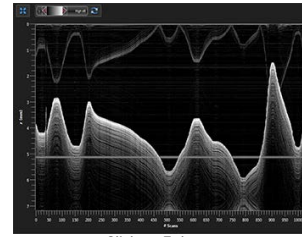

Click to Enlarge  
Several A-Scans at a Single Point Over Time (M-Scan)

## 2D Mode

In the 2D imaging mode, the probe beam scans in one direction, acquiring cross-sectional OCT images which are then displayed in real time. Line averaging before or after the Fast Fourier Transform (FFT) is available, as well as B-Scan averaging. Image display parameters, such as color mapping, can be controlled in this mode. We have also implemented an option for automatic calculation of the optimum contrast and brightness of the displayed OCT images.

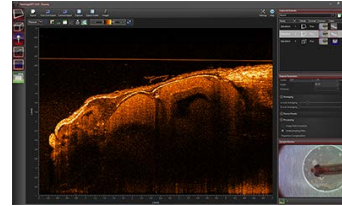

Click to Enlarge  
ThorImageOCT Window in the 2D Mode

## 3D Mode

In the 3D imaging mode, the OCT probe beam scans sequentially across the sample to collect a series of 2D cross-sectional images which are then processed to build a 3D image.

In the ThorImageOCT software, 3D volume datasets can be viewed as orthogonal cross-sectional planes (see below) and volume renderings.

The Sectional View features cross-sectional images in all three orthogonal planes, independent of the orientation in which the data was acquired. The view can be rotated as well as zoomed in and out.

The Rendering View provides a volumetric rendering of the acquired volume dataset. This view enables quick 3D visualization of the sample being imaged. Planes of any orientation can be clipped to expose structures within the volume. The 3D image can be zoomed in and out as well as rotated. Furthermore, the coloring and dynamic range settings can be adjusted.

Utilizing the full potential of our high-performance software in combination with our high-speed OCT systems, we have included a Fast Volume Rendering Mode in the ThorImageOCT software, which serves as a preview for high-resolution 3D acquisitions. In this mode, high-speed volume renderings can be displayed in real-time, providing rapid visualization of samples in three dimensions.

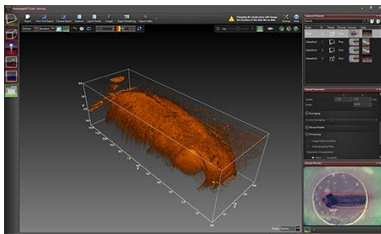

Click to Enlarge  
Rendering View of ThorImageOCT

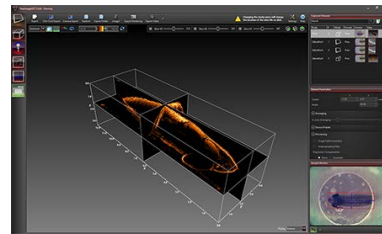

Click to Enlarge  
Sectional View of ThorImageOCT

## Doppler Mode

Doppler OCT imaging comes standard with all OCT systems. In the Doppler mode, phase shifts between adjacent A-scans are averaged to calculate the Doppler frequency shift induced by particle motion or flow. The number of lateral and axial pixels can be modified to change velocity sensitivity and resolution during phase shift calculation. The Doppler images are displayed in the main window with a color map indicating forward- or backward-directed flow, relative to the OCT beam.

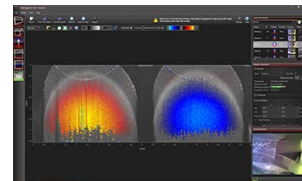

Click to Enlarge  
Doppler dataset showing the velocity of a rotated plastic stick with opposite flow directions.

## Speckle Variance Mode

The speckle variance imaging mode is an acquisition mode which uses the variance of speckle noise to calculate angiographic images. It can be used to visualize three dimensional vessel trees without requiring significant blood flow and without requiring a specific acquisition speed window. The speckle variance data can be overlaid on top of intensity pictures providing morphological information. Different color maps can be used to display the multimodal pictures.

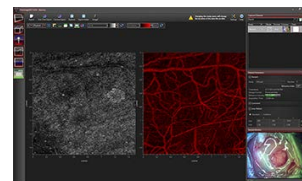

Click to Enlarge

### Externally-Triggered Acquisition

ThorImageOCT and the SDK APIs provide the ability to externally trigger the acquisition of A-Scans. This enables the user to synchronize measurements from different modalities (e.g. vibrometry and synchronized positioning) with an OCT measurement. Synchronization is greatly simplified with all current CameraLink-based Thorlabs OCT systems (a TTL level trigger signal source required). External triggering is available for all imaging modes and can be toggled in the settings dialog in ThorImageOCT.

### Easy Probe Calibration

Changing to a different scan lens kit will generally require a different probe configuration in order to adapt to changes in the optical parameters of the system. When an additional scan lens is purchased for your Thorlabs OCT scanner system, ThorImageOCT enables you to easily create a fitting configuration for your new scan lens by using the calibration sample shipped with the lens and an intuitive step-by-step calibration process (shown to the right).

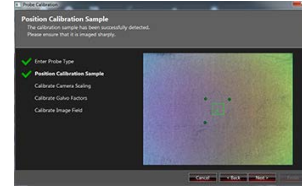

Click to Enlarge  
Probe Calibration Window in ThorImageOCT

### Video Showing Screencast of ThorImageOCT Rendering Capabilities

In this video, OCT images of a finger are acquired and manipulated in the 3D volume and cross section modes.

## MEMS-VCSEL SOURCE & NBSP ;

Optical coherence tomography (OCT) noninvasively and non-destructively generates cross sectional (2D) and volumetric (3D) images of samples by probing them with a light beam and then analyzing the backscattered light. The characteristics of the OCT light source influence a number of performance parameters, including axial resolution, imaging depth, and sensitivity. The Vega Series of OCT systems use a swept-wavelength vertical cavity surface emitting laser (VCSEL) source to provide the probe light beam.

This laser source always emits a narrow linewidth laser beam with long coherence length. During operation, the center wavelength of this single mode emission is quickly tuned across a broad spectral range. As the wavelength sweeps, a detector records the backscattered intensity from the sample as a function of time (wavelength). Because the laser's power is always concentrated at a single wavelength, instead of spread across a wide spectral width, it produces a stronger backscattered signal at each wavelength than is possible with a broadband source possessing comparable total optical power.

### VCSEL Overview

The swept-wavelength laser source used in the Vega is a vertical cavity surface emitting laser (VCSEL) that possesses a microelectromechanical system (MEMS) mirror and a single-longitudinal-mode cavity. Vertical cavity surface emitting lasers are semiconductor-based devices that emit light perpendicular to the chip surface, as shown in Figure 1. VCSELs were originally developed as low-cost, low-power alternatives to edge-emitting diodes, mainly for high-volume datacom applications. Quickly thereafter, the advantages of VCSELs became more widely acknowledged, leading to them being preferred light sources over edge-emitters in many applications. Compared to edge-emitting sources, VCSELs offer superior output beam quality and single mode operation.

Thorlabs' laser was developed by Praveium Research, in collaboration with Thorlabs and the Massachusetts Institute of Technology (MIT). MEMS-tunable VCSELs have existed for several years; however, the limited tuning range and output power of these devices have precluded them from being used in OCT applications. Our design uses a low mass MEMS mirror to vary the cavity length of the laser, and therefore the output wavelength, as well as a semiconductor optical amplifier (SOA). With these, Thorlabs' swept-wavelength laser achieves higher output power, a broader wavelength tuning range, and a more uniform output across the full spectrum than other VCSELs. It also operates mode-hop-free throughout the entire tuning range, which is in excess of 100 nm. Key characteristics of our laser's operation, which are of particular benefit to OCT applications, are:

- Rapid Sweep Speed
- Broad Tuning Range
- Long Coherence Length
- High Laser Output Power

### Rapid Sweep Speed

Applications using OCT demand high-speed imaging without sacrificing imaging quality. Fast imaging rates allow better time resolution, dense collection of 3D datasets, and decreased laser exposure times to the sample.

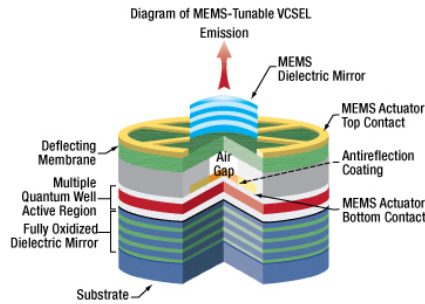

Click to Enlarge

**Figure 1:** Praveium's MEMS-Tunable VCSEL is an innovative design that offers high-speed and broadband emission with long coherence length. This is an ideal combination for an OCT swept laser source.

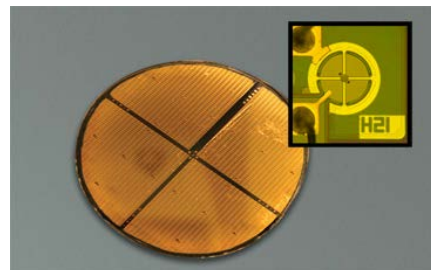

Click to Enlarge

**Figure 2:** MEMS-tunable VCSELs can be densely packed on a single wafer to increase the potential yield. The inset shows a single MEMS-tunable VCSEL device after fabrication. The overall size of the MEMS-tunable VCSEL is approximately 600  $\mu\text{m}$  x 600  $\mu\text{m}$  square.

Currently, there exist a few swept laser sources that offer high-speed scanning. Fourier domain mode-locked lasers, for example, achieve extremely high imaging speeds but require the use of very long fiber optic delays in the laser cavity and can only operate in wavelength ranges where the fiber loss is low. Of the commercially available high-speed swept lasers, many operate with multiple longitudinal modes or have long cavity lengths, which limit coherence length or tuning speed, respectively.

The low mass of the MEMS-tuning mirror in a MEMS-based tunable VCSEL and the short cavity length both contribute to its high-speed operation. The short cavity length also places only one mode in the gain spectrum, enabling single-mode continuous operation. In addition, the short cavity design enables nearly identical spectra in the forward and backward sweeps. We have recently measured greater than 500 kHz sweep rates using a MEMS-tunable VCSEL prototype, without using optical multiplexing to increase the sweep speed.

### Broad Tuning Range

High-resolution imaging depends on the overall tuning bandwidth of the swept laser source. Praevium boasts the broadest bandwidth MEMS-tunable VCSEL that has ever been developed. A unique design incorporating broadband, fully oxidized mirrors, as well as wideband gain regions and thin active regions, has currently resulted in greater than 100 nm of continuous mode-hop-free tuning, centered around 1300 nm. For details, please see Figure 3.

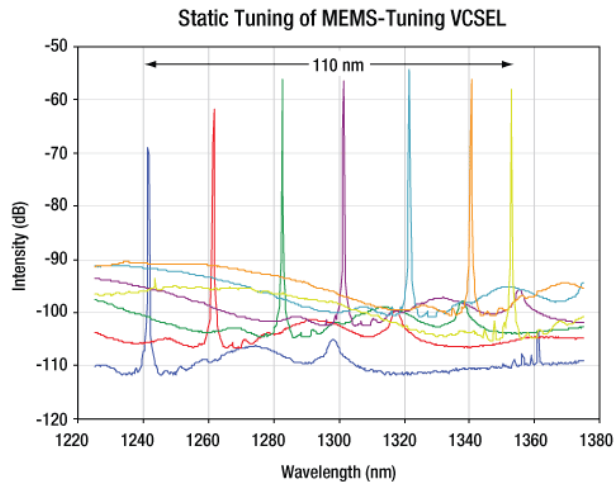

Click to Enlarge  
**Figure 3:** MEMS-tunable VCSELs are capable of tuning over 100 nm. Here we show single-mode operation over a 110 nm spectral tuning range centered at 1300 nm.

### Long Coherence Length

A significant limitation to most OCT systems is the depth of view (maximum imaging depth range). Especially in clinical applications, where sample thickness, patient motion, and sample location cannot be controlled, a long depth of view is advantageous. A long coherence length alone, however, is not enough. Image sensitivity needs to be virtually unaffected throughout the entire depth. Due to the micron-scale cavity length of the VCSEL and single mode, mode-hop-free operation, we have measured coherence lengths of greater than 100 mm from our MEMS-tunable VCSEL with nearly no signal degradation. Currently limited by detector bandwidth, we are confident that the MEMS-tunable VCSEL is able to achieve even longer imaging depths than have been measured to date. This remarkable depth of view will not only benefit the medical imaging community but also open doors to other applications such as large objective surface profiling, fast frequency domain reflectometry, and fast spectroscopic measurements with high spectral resolution.

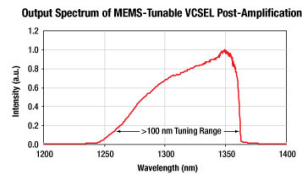

Click to Enlarge  
**Figure 4:** Spectrum of MEMS-tunable VCSEL operating at 200 kHz, with a center wavelength around 1310 nm, and post amplification using an SOA. Continuous development of these sources has indicated the capability of tuning over 110 nm of bandwidth.

### High Output Power

Increased imaging speed often comes at the cost of decreased output power and/or optical power on the sample. One advantage of edge-emitting light sources over VCSELs is that they can emit greater output powers. As a general rule, most OCT imaging applications need a minimum of 20 mW of laser output power to maintain image quality when operating at faster scan rates. To reach this goal, the MEMS-tunable VCSEL is coupled with a semiconductor optical amplifier (SOA) to achieve greater than 25 mW of power. An additional advantage of this post-amplification scheme is that the SOA reshapes the MEMS-VCSEL output spectrum such that it is much more uniform.

### Additional Considerations and Manufacturing Capabilities

A special feature of the MEMS-tunable VCSEL is that it is scalable for different wavelengths. Through innovative combinations of gain materials and dielectric mirrors, a wide wavelength range in the visible or near infrared can be reached, enabling expansion of this new family of light sources.

As we further develop this light source, we look forward to finding new and exciting applications for its use. Please contact us to discuss how a MEMS-tunable VCSEL may advance your research.

### Fabrication of a MEMS-Tunable VCSEL

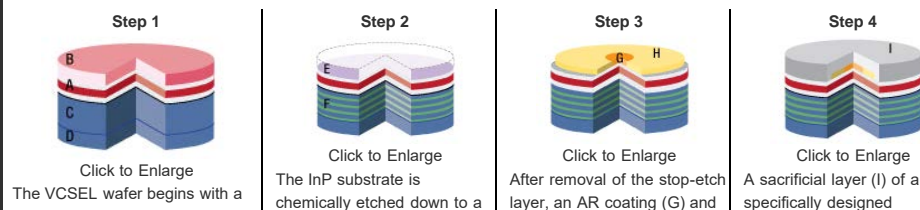

multiple quantum well (MQW) active region (A) that is grown on an InP substrate (B) and bonded to a GaAs-based mirror (C) grown on a GaAs substrate (D).

strategically located stop-etch layer (E). The GaAs-based mirror is oxidized to create a wideband dielectric mirror (F).

annular MEMS bottom actuator contact (H) are deposited on top of the MQW active region.

thickness and composition is deposited.

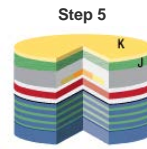

Click to Enlarge  
A membrane layer (J) and annular top MEMS actuator contact (K) are deposited on top of the sacrificial layer.

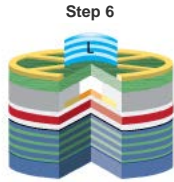

Click to Enlarge  
Finally, a dielectric mirror (L) is deposited and patterned. The top MEMS contact is further patterned to complete creation of the actuator. The sacrificial layer is undercut to leave a suspended, moveable top mirror above the MQW structure, producing a VCSEL with a MEMS-based tuning element in a single device.

## OCT TUTORIAL

### Optical Coherence Tomography Tutorial

Optical Coherence Tomography (OCT) is a noninvasive optical imaging modality that provides real-time, 1D depth, 2D cross-sectional, and 3D volumetric images with micron-level resolution and millimeters of imaging depth. OCT images consist of structural information from a sample based on light backscattered from different layers of material within the sample. It can provide real-time imaging and is capable of being enhanced using birefringence contrast or functional blood flow imaging with optional extensions to the technology.

Thorlabs has designed a broad range of OCT imaging systems that cover several wavelengths, imaging resolutions, and speeds, while having a compact footprint for easy portability. Also, to increase our ability to provide OCT imaging systems that meet each customer's unique requirements, we have designed a highly modular technology that can be optimized for varying applications.

### Application Examples



Art Conservation



Drug Coatings



3D Profiling



In-vivo



Small Animal



Biology



Tissue Birefringence



Mouse Lung



Retina Cone Cells

OCT is the optical analog of ultrasound, with the tradeoff being lower imaging depth for significantly higher resolution (see Figure

1). With up to 15 mm imaging range and better than 5 micrometers in axial resolution, OCT fills a niche between ultrasound and confocal microscopy.

In addition to high resolution and greater imaging depth, the non-contact, noninvasive advantage of OCT makes it well suited for imaging samples such as biological tissue, small animals, and materials. Recent advances in OCT have led to a new class of technologies called Fourier Domain OCT, which has enabled high-speed imaging at rates greater than 700,000 lines per second.<sup>1</sup>

Fourier Domain Optical Coherence Tomography (FD-OCT) is based on low-coherence interferometry, which utilizes the coherent properties of a light source to measure optical path length delays in a sample. In OCT, to obtain cross-sectional images with micron-level resolution, and interferometer is set up to measure optical path length differences between light reflected from the sample and reference arms.

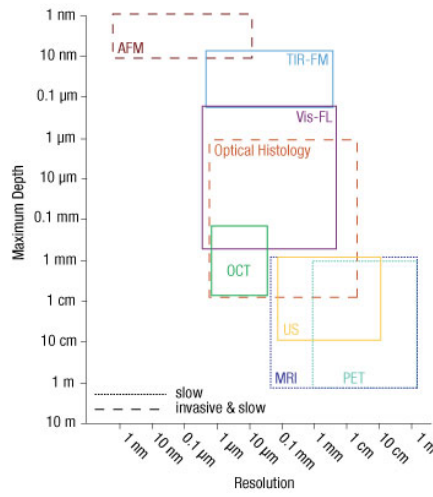

Click to Enlarge  
Figure 1

There are two types of FD-OCT systems, each characterized by its light source and detection schemes: Spectral Domain OCT (SD-OCT) and Swept Source OCT (SS-OCT). In both types of systems, light is divided into sample and reference arms of an interferometer setup, as illustrated in Fig 2. SS-OCT uses coherent and narrowband light, whereas SD-OCT systems utilize broadband, low-coherence light sources. Back scattered light, attributed to variations in the index of refraction within a sample, is recoupled into the sample arm fiber and then combined with the light that has traveled a fixed optical path length along the reference arm. A resulting interferogram is measured through the detection arm of the interferometer.

The frequency of the interferogram measured by the sensor is related to depth locations of the reflectors in the sample. As a result, a depth reflectivity profile (A-scan) is produced by taking a Fourier transform of the detected interferogram. 2D cross-sectional images (B-scans) are produced by scanning the OCT sample beam across the sample. As the sample arm beam is scanned across the sample, a series of A-scans are collected to create the 2D image.

Similarly, when the OCT beam is scanned in a second direction, a series of 2D images are collected to produce a 3D volume data set. With FD-OCT, 2D images are collected on a time scale of milliseconds, and 3D images can be collected at rates now below 1 second.

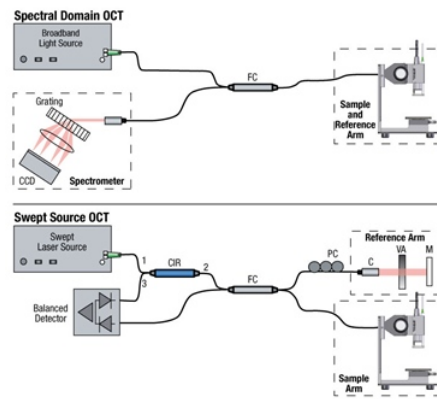

Click to Enlarge  
Figure 2

### Spectral Domain OCT vs. Swept Source OCT

Spectral Domain and Swept Source OCT systems are based on the same fundamental principle but incorporate different technical approaches for producing the OCT interferogram. SD-OCT systems have no moving parts and therefore have high mechanical stability and low phase noise. Availability of a broad range of line cameras has also enabled development of SD-OCT systems with varying imaging speeds and sensitivities.

SS-OCT systems utilize a frequency swept light source and photodetector to rapidly generate the same type of interferogram. Due to the rapid sweeping of the swept laser source, high peak powers at each discrete wavelength can be used to illuminate the sample to provide greater sensitivity with little risk of optical damage.

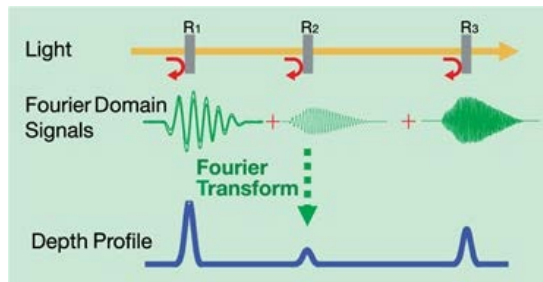

Click to Enlarge

### FD-OCT Signal Processing

In Fourier Domain OCT, the interferogram is detected as a function of optical frequency. With a fixed optical delay in the reference arm, light reflected from different sample depths produces interference patterns with the different frequency components. A Fourier transform is used to resolve different depth reflections, thereby generating a depth profile of the sample (A-scan).

<sup>1</sup>V. Jayaraman, J. Jiang, H. Li, P. Heim, G. Cole, B. Potsaid, J. Fujimoto, and A. Cable, "OCT Imaging up to 760 kHz Axial Scan Rate Using Single-Mode 1310 nm MEMs-Tunable VCSELs with 100 nm Tuning Range," CLEO 2011 - Laser Applications to Photonic Applications, paper PDPB2 (2011).



Brochure and Configuration Chart

The buttons below link to PDFs of printable materials and a graphical customization guide for our Vega Series OCT Systems.



### Vega Series OCT Systems

VEGA SERIES PRECONFIGURED SYSTEM	
ITEM #	VEG110C1
Base Unit	VEG110
Center Wavelength	1300 nm
Imaging System	OCTG-1000N (Standard Scanner)
Scan Lens Kit	OCT-L100
Accessories	OCT-STD000M and OCT-200-00M

**VEG110C1**  
The VEG110C1 configuration consists of a VEG110 long-range imaging base unit, standard scanner, long depth of focus scan lens kit, stand, and stage.

VEGA SERIES OCT BASE UNIT SPECIFICATIONS	
ITEM #	VEG110
Center Wavelength	1300 nm
Imaging Depth (Air/Water)	1.7 mm / 1.3 mm
Axial Resolution (Air/Water)	7.0 µm / 5.3 µm
A-Scan Line Rate	1.2 kHz
Sensitivity	107 dB (at 1.2 kHz)
Base Unit Dimensions	121 mm x 102 mm x 210 mm

Typical Values Measured Using a Scanner With Dual Path Setup

**THORLABS** | [www.thorlabs.com](http://www.thorlabs.com)

SELECTION GUIDE

Thorlabs offers a variety of OCT Imaging Systems to meet a range of application requirements. The OCT base unit and scan lens kit are key to OCT system performance. Significant performance characteristics, including axial resolution, A-Scan rate, and imaging depth, are entirely or strongly dependent on the design of the OCT base unit. The choice of scan lens kit determines other parameters, such as lateral resolution and field of view. Thorlabs offers a variety of OCT base units and scan lens kits that provide foundations for systems with a wide range of capabilities. The tables below present key performance parameters of our base units and include links to our other OCT imaging system pages. We encourage you to contact us directly at [oct@thorlabs.com](mailto:oct@thorlabs.com) or via our online request form to discuss specific imaging requirements.

900 nm OCT Base Units

Item #	CAL110 <sup>a</sup>	GAN210 <sup>a</sup>	GAN610 <sup>a</sup>	GAN220 <sup>a</sup>	GAN620 <sup>a</sup>
Series Name (Click for Link)	Callisto	Ganymede			
Key Performance Feature(s)	Laptop PC for Maximum Portability	High Resolution		Very High Resolution	
		General Purpose	High Speed	General Purpose	High Speed
Center Wavelength	930 nm	930 nm		900 nm	
Imaging Depth <sup>b</sup> (Air/Water)	1.7 mm / 1.3 mm	2.9 mm / 2.2 mm	2.7 mm / 2.0 mm	1.9 mm / 1.4 mm	
Axial Resolution <sup>b</sup> (Air/Water)	7.0 µm / 5.3 µm	6.0 µm / 4.5 µm		3.0 µm / 2.2 µm	
A-Scan Line Rate	1.2 kHz	5.5 kHz to 36 kHz	5 kHz to 248 kHz	5.5 kHz to 36 kHz	5 kHz to 248 kHz
Sensitivity (Max) <sup>c</sup>	107 dB (at 1.2 kHz)	101 dB (at 5.5 kHz)	102 dB (at 5 kHz)	101 dB (at 5.5 kHz)	102 dB (at 5 kHz)
OCT Type	Spectral Domain				

- These Item #s are OCT base units that can be customized using a wide selection of OCT scanners, lens kits, and optional accessories.
- Axial resolution and actual imaging depth are dependent on the optical properties of the sample being imaged.
- Values for the Callisto and Ganymede systems are typical and were measured using a scanner with a common reference/sample path and 50% path split.

1300 nm OCT Base Units

Item #	TEL210 <sup>a</sup>	TEL310 <sup>a</sup>	TEL220 <sup>a</sup>	TEL320 <sup>a</sup>	TEL210PS <sup>a</sup>	TEL220PS <sup>a</sup>	VEG110 <sup>a</sup>
Series Name (Click for Link)	Telesto				Telesto PS-OCT		Vega
Key Performance Feature(s)	High Imaging Depth		High Resolution		High Imaging Depth	High Resolution	Long Imaging Range
	General Purpose	High Speed	General Purpose	High Speed	Polarization-Sensitive Imaging		High Speed

<b>Center Wavelength</b>	1325 nm		1300 nm		1325 nm	1300 nm	1300 nm
<b>Imaging Depth<sup>b</sup> (Air/Water)</b>	7.0 mm / 5.3 mm		3.5 mm / 2.6 mm		7.0 mm / 5.3 mm	3.5 mm / 2.6 mm	12 mm
<b>Axial Resolution<sup>b</sup> (Air/Water)</b>	12 $\mu$ m / 9.0 $\mu$ m		5.5 $\mu$ m / 4.2 $\mu$ m		12 $\mu$ m / 9.0 $\mu$ m	5.5 $\mu$ m / 4.2 $\mu$ m	16 $\mu$ m
<b>A-Scan Line Rate</b>	5.5 kHz to 76 kHz	10 kHz to 146 kHz	5.5 kHz to 76 kHz	10 kHz to 146 kHz	5.5 kHz to 76 kHz	5.5 kHz to 76 kHz	100 kHz
<b>Sensitivity (Max)<sup>c</sup></b>	111 dB (at 5.5 kHz)	109 dB (at 10 kHz)	111 dB (at 5.5 kHz)	109 dB (at 10 kHz)	109 dB (at 5.5 kHz)	109 dB (at 5.5 kHz)	101 dB (at 100 kHz)
<b>OCT Type</b>	Spectral Domain						Swept Source

- These Item #s are OCT base units that can be customized using a wide selection of OCT scanners, lens kits, and optional accessories.
- Axial resolution and actual imaging depth are dependent on the optical properties of the sample being imaged.
- Values for the Telesto systems are typical and were measured using a scanner with a common reference/sample path and 50% path split. The value measured for the Vega system is typical and was measured using a scanner with a dual path setup.

### Vega Series Complete Preconfigured System

- ▶ Complete Preconfigured 1300 nm OCT Imaging System
- ▶ High-Speed and High-Depth Imaging (See Tables Below)
- ▶ Complete System Configuration Listed in Table to the Lower Left

Thorlabs offers this complete, preconfigured Vega OCT system, which is fully compatible with all Vega Series OCT components. The VEG110C1 configuration features a center wavelength of 1300 nm and is designed for high-speed and deep-imaging applications.

This Vega Series OCT system configuration is built completely from components sold in sections located lower on this page. This preconfigured system includes the three mandatory OCT system core components (the base unit, a scanning system, and a scan lens kit), as well as two optional accessories (scanner stand and translation stage). For more information about a component included in the preconfigured systems, click on the component description in the table to the lower left to navigate down to the related section on this page.

The VEG110C1 configuration is fully compatible with all Vega Series OCT components. For information about this system or to inquire about custom configurations, please contact [oct@thorlabs.com](mailto:oct@thorlabs.com).

Preconfigured System Included Components	
<b>System Item #</b>	<b>VEG110C1</b>
<b>Base Unit</b>	VEG110
<b>Scanning System</b>	OCTG-1300NR (Standard Scanner)
<b>Scan Lens Kit</b>	OCT-LK4
<b>Accessories: Stand and Stage</b>	OCT-STAND(/M) (Scanner Stand) and OCT-XYR1(/M) (Translation Stage)

- Click on the component description to navigate down to the related section on this page.

Preconfigured System Key Specifications	
<b>System Item #</b>	<b>VEG110C1</b>
<b>Imaging Depth (Air/Water)</b>	12 mm / 9.0 mm
<b>Axial Resolution (Air/Water)</b>	16 $\mu$ m / 12 $\mu$ m
<b>Lateral Resolution</b>	20 $\mu$ m
<b>A-Scan/Line Rate</b>	100 kHz
<b>Sensitivity</b>	101 dB

Part Number	Description	Price	Availability
VEG110C1	Swept Source OCT Imaging System, 1300 nm, 100 kHz	\$80,000.00	Lead Time

### Base Unit (Required OCT System Component)

- ▶ 1300 nm Center Wavelength
- ▶ 12 mm Imaging Depth
- ▶ 16  $\mu$ m Axial Resolution in Air
- ▶ 101 dB Sensitivity
- ▶ 100 kHz A-Scan Rate

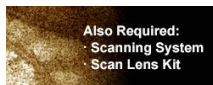

**Also Required:**  
 Scanning System  
 Scan Lens Kit

To be functional, an OCT system build must include a base unit, a scanning system, and a scan lens kit.

The imaging performance of any OCT system is largely dependent on the design and components incorporated into the base unit. All of Thorlabs' OCT Base Units include an OCT engine, high-performance computer, pre-installed software, and a software development kit (SDK).

The Vega OCT Base Unit is separated into two individual housings, which together function

Base Unit Item #	VEG110
<b>Description</b>	<b>High-Speed and Long-Range Imaging</b>
<b>Center Wavelength</b>	1300 nm
<b>Imaging Depth (Air/Water)</b>	12 mm / 9.0 mm
<b>Axial Resolution (Air/Water)</b>	16 $\mu$ m / 12 $\mu$ m
<b>A-Scan Line Rate</b>	100 kHz
<b>Sensitivity<sup>a</sup></b>	101 dB (at 100 kHz)
<b>Minimum Pixels per A-Scan</b>	1360
<b>Compatible Scanners</b>	OCTP-1300NR(/M) , OCTG-1300NR, and OCTH-1300NR

as a single engine. One housing includes the microelectromechanical system based vertical-cavity surface-emitting laser (MEMS-VCSEL) swept source, and the other contains the imaging module. Integrated into the imaging module are the scanning electronics and an interferometer with a balanced detector. The overall dimensions of the two housings, stacked on one another, are 320 mm x 320 mm x 215 mm (12.6" x 12.6" x 8.5"). Please note that, in addition to this base unit, a fully operational OCT system must also include one scanning system and one scan lens kit, both of which are sold separately below. As the dual-path interferometer built into the Vega OCT Base Unit includes the reference arm, the Vega OCT system scanners are configured without a beamsplitter or interferometer reference arm.

#### High-Speed and Deep-Imaging Base Unit

Integrated into Thorlabs' VEG110 High-Speed and Deep-Imaging Base Unit is an optimized MEMS-VCSEL swept-wavelength laser source. We have designed this laser to achieve the fast sweep rate of 100 kHz while providing 100 nm of tuning bandwidth, which enables the high 12 mm imaging depth and 16  $\mu$ m axial resolution that characterizes the Vega OCT system. This base unit is an ideal choice for simultaneously achieving high-speed and long-range imaging of highly scattering samples in an air medium. The VEG110 Base Unit has a sensitivity of 101 dB and an A-scan rate of 100 kHz.

- Typical Values Measured Using a Scanner with Dual Path Setup

Computer Specifications <sup>a</sup>	
Operating System	Windows 10, 64 Bit
Processor	Quad Core, 3.6 GHz
Memory	32 GB
Hard Drive	512 GB SSD
Data Acquisition	ATS9350 High Speed Digitizer

- Computer Specifications Subject to Change

Part Number	Description	Price	Availability
VEG110	Vega OCT Base Unit, 1300 nm, 16 $\mu$ m Resolution, 100 kHz	\$68,500.00	Lead Time

### Scanning System (Required OCT System Component)

- ▶ Scan an OCT Light Source Beam Across a Sample to Acquire 2D or 3D Images
- ▶ Three Available Options
  - ▶ Standard Scanner for High Stability and Ease-of-Use
  - ▶ User-Customizable Scanners with Open Construction for Customization of the Optical Beam Path
  - ▶ Portable Handheld Scanner for Applications Requiring High Mobility



Click to Enlarge Standard OCT Scanner



Click to Enlarge User-Customizable OCT Scanner



Click to Enlarge Handheld OCT Scanner

Thorlabs' OCT Scanning Systems rapidly scan the OCT light beam across the back aperture of the scan lens, which enables 2D cross-sectional and 3D volumetric imaging of the sample. OCT applications can vary widely, from live animal imaging to industrial materials analysis, with each requiring a different set of scanning parameters. We currently offer three types of beam scanning systems for use with our Vega Base Unit: standard, user-customizable, and handheld.

Scanner Type	Item #	Compatible Base Unit
Standard Scanner	OCTG-1300NR	VEG110
User-Customizable Scanner	OCTP-1300NR/(M)	
Handheld Scanner <sup>a</sup>	OCTH-1300NR	

In the case of the Vega OCT systems, the reference interferometer arm is enclosed in the Vega Base Unit, described above. The Vega's beam scanning systems are therefore configured without the reference arm and beamsplitter. Dispersion effects from the sample (e.g., imaging through water or glass) can be compensated for using the included ThorImage OCT software.

- Sample Z-Spacers Recommended When Using OCTH-1300NR

All scanners are equipped with an integrated camera that can obtain real-time *en face* video of the sample during OCT measurements when used with our ThorImage OCT software (see the *Software* tab for details). Illumination of the sample is provided by a ring of user-adjustable white light LEDs around the exit aperture of each scanner.

#### Standard Scanner

The OCTG-1300NR Standard Scanner is ideal for imaging applications that require a stable, easy-to-operate setup. The entire design of the standard scanner is contained within a rugged, light-tight housing that minimizes the risk of misalignment.

#### User-Customizable Scanner

The OCTP-1300NR/(M) User-Customizable Scanner is designed with an open construction to enable easy customization of the optical beam path using Thorlabs' standard optomechanical components. This scanner features SM1 (1.035"-40) ports and 4-40 tapped holes at several locations that allow mounting of SM1-threaded or 30 mm cage-compatible components, respectively. The scan lens port is directly compatible with either M25 x 0.75 or SM1-threaded components, and can be converted to other thread standards, such as RMS (0.800"-36) via our selection of thread adapters. Additional scanning and non-scanning optical input/output ports are available for integration of a laser for fluorescence excitation or additional sample illumination.

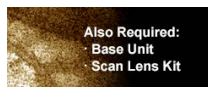

To be functional, an OCT system build must include a base unit, a scanning system, and a scan lens kit.



Click to Enlarge OCTH-1300NR Handheld Scanner with OCTH-AIR30 Sample Z-Spacer

#### Compact Handheld Scanner

The compact and lightweight OCTH-1300NR Handheld Scanner is specifically designed for applications requiring high mobility. Easy access buttons located directly on the scanner enable fingertip control of our ThorImage OCT Software. Users can program each button from a selection of imaging and acquisition software controls and the software uses visual and audio feedback for button presses. Compatible scan lens kits and sample z-spacers for the OCTH-1300NR are sold below; z-spacers help maintain the correct working distance when using the handheld scanner. Please note that due to the limitations of the internal MEMS scanner, the frame rate (i.e. B-Scan rate) is limited to 25 frames per second when using the handheld scanner.

Part Number	Description	Price	Availability
OCTP-1300NR/M	User-Customizable Scanner for 1300 nm SS-OCT Systems, Metric	\$8,000.00	Lead Time
OCTG-1300NR	Standard Scanner for 1300 nm SS-OCT Systems	\$7,500.00	Lead Time
OCTH-1300NR	Handheld Scanner for 1300 nm SS-OCT Systems	\$9,500.00	Lead Time
OCTP-1300NR	User-Customizable Scanner for 1300 nm SS-OCT Systems, Imperial	\$8,000.00	Lead Time

## Scan Lens Kit (Required OCT System Component)

- ▶ Telecentric Scan Lenses Provide a Flat Imaging Plane
- ▶ Lens AR Coated for  $1315 \pm 65$  nm
- ▶ Scan Lens Kits for Standard / User-Customizable Scanners Include
  - ▶ Telecentric Scan Lens
  - ▶ Illumination Tube
  - ▶ IR Card
  - ▶ Calibration Target
- ▶ Compact Scan Lens Kits Designed for the OCTH-1300NR Handheld Scanner with Integrated Scan Lens and Illumination Ring

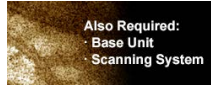

To be functional, an OCT system build must include a base unit, a scanning system, and a scan lens kit.



Click to Enlarge  
The illumination tube guides the white light for the live video feed around the scan lens. As the OCT probe beam passes through the scan lens and is not affected by the illumination guide, the use of the illumination guide is optional. Removing the illumination guide can be convenient for accommodating applications with tight space constraints.

Thorlabs' Scan Lens Kits enable easy exchange of scan lenses in an OCT system, providing the flexibility to tailor imaging resolution or working distance for each application. Based on our line of OCT telecentric scan lenses, these lens kits minimize image distortion without extensive post-image processing and maximize coupling of the light scattered or emitted from the sample surface into the detection system. As seen in the table below, we offer scan lens kits compatible with the standard (Item # OCTG-1300NR) and user-customizable (Item # OCTP-1300NR/(M)) scanners, as well as two lens kits compatible with the handheld scanner (Item # OCTH-1300NR).

Each kit includes a telecentric scan lens, illumination tube, IR card, and calibration target. The included illumination tube serves as a light guide that channels light from the LED illumination ring down to the sample area. The IR card and calibration target are provided for calibration of the scanning mirror and lens kit, ensuring the best image quality when swapping between scan lenses.

Item #	OCT-LK2	OCT-LK3	OCT-LK4	OCTH-LK20	OCTH-LK30
Click Image to Enlarge					
Design Wavelength	1300 nm			1300 nm	
Compatible Scanner	OCTG-1300NR (Standard) or OCTP-1300NR/(M) (User-Customizable)			OCTH-1300NR Handheld	
Lateral Resolution <sup>a</sup>	7 $\mu$ m	13 $\mu$ m	20 $\mu$ m	16.0 $\mu$ m	24.0 $\mu$ m
Focal Length	18 mm	36 mm	54 mm	20 mm	30 mm
Working Distance	3.4 mm (with Tube) <sup>b</sup> 7.5 mm (without Tube)	24.9 mm (with Tube) <sup>b</sup> 25.1 mm (without Tube)	41.6 mm (with Tube) <sup>b</sup> 42.3 mm (without Tube)	12 mm	22 mm
Field of View	6 mm x 6 mm	10 mm x 10 mm	16 mm x 16 mm	$\varnothing$ 8 mm	$\varnothing$ 10 mm
Lens Threading	M25 x 0.75	M25 x 0.75	M25 x 0.75	M20 x 0.5 (For Z-Spacer) M14 x 0.5 (For OCTH-1300)	

- $1/e^2$  Beam Diameter at Focus
- The illumination tube is user-removable.

Part Number	Description	Price	Availability
OCT-LK2	OCT Scan Lens Kit, 18 mm FL, 1300 nm / 1325 nm	\$1,938.00	Lead Time
OCT-LK3	OCT Scan Lens Kit, 36 mm FL, 1300 nm / 1325 nm	\$1,326.00	Lead Time
OCT-LK4	OCT Scan Lens Kit, 54 mm FL, 1300 nm / 1325 nm	\$1,326.00	Lead Time
OCTH-LK20	OCT Scan Lens Kit for OCTH-1300, 20 mm FL	\$1,009.80	Lead Time
OCTH-LK30	OCT Scan Lens Kit for OCTH-1300, 30 mm FL	\$1,009.80	Lead Time

## Sample Z-Spacers (Optional Accessories)

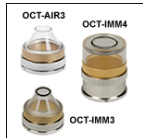

Click to Enlarge  
Z-Spacers for the OCTG-1300NR and OCTP-1300NR/(M) Scanners



Click to Enlarge  
Z-Spacers for the OCTH-1300NR Handheld Scanner

- ▶ Sample Z-Spacers Position Scanner at Optimal Working Distance From Sample
- ▶ Ring (Air) and Immersion (Liquid) Z-Spacers Available
- ▶ Two Z-Spacers Recommended for Use with OCTH-1300NR Handheld Scanner

Thorlabs offers both ring and immersion style sample Z-spacers that enable optimal positioning of a scanning system relative to the sample. The OCT-AIR3, OCT-IMM3, and OCT-IMM4 Z-Spacers feature knurled rings that allow the spacing distance to be adjusted and locked in place for increased stability. Several Z-spacer options are available; please see the table below for compatibility with our scanners and lens kits.

Additionally, we offer two ring-style Z-spacers that are designed specifically for the OCTH-1300NR Handheld Scanner; these spacers greatly assist in maintaining the correct sample working distance when using the handheld scanner. The spacing distance on the OCTH-AIR20 and OCTH-AIR30 Z-Spacers can be adjusted by rotating the spacer.

Our ring-style Z-spacers provide a distance guide between the scanner and sample. The sample is in contact with the ring-shaped tip of the spacer and should only be used when air is the scanning medium. In contrast, our immersion spacers are equipped with a glass plate that contacts the sample surface within the scanning area. Unlike the ring-style spacers, immersion spacers enable access to samples contained within a liquid environment while also providing sample stabilization. Better index matching and a tilted glass plate also help reduce strong back reflections from the sample surface and enhances the contrast of the image.

Item # <sup>a</sup>	Type	Adjustable	Adjustment Range	Lockable	Compatible Scanner	Compatible Scan Lens Kit

OCT-AIR3	Ring (Air)	Yes	+3.5 mm / -1.0 mm	Yes	OCTG-1300NR OCTP-1300NR(M)	OCT-LK3
OCT-IMM3	Immersion	Yes	+3.4 mm / -1.1 mm	Yes		
OCT-IMM4	Immersion	Yes	+1.0 mm / -17.0 mm	Yes		
OCTH-AIR20	Ring (Air)	Yes	±4 mm	No	OCTH-1300NR <sup>a</sup>	OCTH-LK20
OCTH-AIR30	Ring (Air)	Yes	±2 mm	No		OCTH-LK30

- We recommend purchasing a sample z-spacer if using the OCTH-1300NR handheld scanner.

Part Number	Description	Price	Availability
OCT-AIR3	Ring-Style Sample Z-Spacer for OCT-LK3(-BB) Scan Lens Kit	\$728.28	Lead Time
OCT-IMM3	Immersion-Style Sample Z-Spacer for OCT-LK3(-BB) Scan Lens Kit	\$884.34	Lead Time
OCT-IMM4	Immersion-Style Sample Z-Spacer for OCT-LK4(-BB) Scan Lens Kit	\$988.38	Lead Time
OCTH-AIR20	Ring-Style Sample Z-Spacer for OCTH-LK20(-BB) Scan Lens Kit	\$187.68	Lead Time
OCTH-AIR30	Ring-Style Sample Z-Spacer for OCTH-LK30(-BB) Scan Lens Kit	\$187.68	Lead Time

### Scanner Stand (Optional Accessory)

- ▶ Recommended Stand for Mounting Standard or User-Customizable Scanners
- ▶ Focus Block with Coarse/Fine Z-Axis Travel on Ø1.5" Stainless Steel Post
- ▶ 12" x 14" (300 mm x 350 mm) Aluminum Breadboard with 1/4"-20 (M6) Tapped Holes

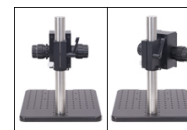

Click for Details  
The focus block can be rotated 45° to move the scanner head away from the sample.

For convenient mounting of our Standard or User-Customizable Scanners, we offer a scanner stand that is ideal for use in vibration-sensitive studies such as angiography. It consists of a post-mounted focus block with knobs that provide both coarse (40 mm/rev) and fine (225 µm/rev) z-axis travel. A rotation and height collar underneath the focus block allows it to rotate 45° in order to move the scanner head away from the sample to make adjustments.

The focus block attaches to a 12" x 14" (300 mm x 350 mm) aluminum breadboard via the included Ø1.5" post. The aluminum breadboard has side grips and rubber feet for easy lifting and transportation. There is an array of 1/4"-20 (M6) tapped holes for mounting optomechanics. Four extra 1/4"-20 (M6) tapped holes allow the mounting of the OCT-XYR1 Translation Stage (sold below) to the OCT-STAND and the OCT-XYR1/M Translation Stage to the OCT-STAND/M directly underneath the scan lens. A 1/4"-20 (M6) counterbore is also provided for securing the Ø1.5" post.

Part Number	Description	Price	Availability
OCT-STAND/M	Stand for Standard and User-Customizable OCT Scanning Systems, M6 Tapped Holes	\$2,040.00	5-8 Days
OCT-STAND	Stand for Standard and User-Customizable OCT Scanning Systems, 1/4"-20 Tapped Holes	\$2,040.00	Today

### Translation Stage (Optional Accessory)

- ▶ Optional Translation Stage with 0.5" (13 mm) of XY Travel and 360° Rotation
- ▶ Includes Cover Plate for Sample Mounting
- ▶ Can Mount Optomechanics by Removing Cover Plate

Specifications	
Horizontal Load Capacity (Max)	10 lbs (4.5 kg)
Mounting Platform Dimensions	Ø4.18" (Ø106 mm)
Stage Height	1.65" (41.8 mm)
Linear Translation Range	1/2" (13 mm)
Travel per Revolution	0.025" (0.5 mm)
Graduation	0.001" (10 µm) per Division



Click to Enlarge  
The cover plate is removable for access to tapped holes and the SM1-threaded central hole.

Precise translation and rotation are often required for optimal positioning of a sample before and during OCT imaging. The OCT-XYR1(M) is an XY linear translation stage with a rotating platform and solid plate for sample mounting and easy cleaning. The OCT-XYR1 or OCT-XYR1/M stage can be secured to the OCT-STAND or OCT-STAND/M, respectively, using the 1/4" (M6) counterbores at the corners. The top plate is removable for access to 4-40, 8-32 (M4), and 1/4"-20 (M6) tapped holes and an SM1-threaded (1.035"-40) central hole for mounting optomechanical components. The XYR1A Solid Sample Plate can be purchased separately as a direct replacement for the top plate.

The X and Y micrometers offer 1/2" (13 mm) of travel with graduations every 0.001" (10 µm). The stage's rotation and translation can be freely changed without compromising the stability of attached components. An engraved angular scale along the outer edge of the stage's rotating platform allows the user to set the angular orientation of the stage, which can then be fixed using the 5/64" (2 mm) hex locking setscrew. Locking the rotation of the stage does not prevent XY translation using the actuators.

Part Number	Description	Price	Availability
OCT-XYR1/M	XY Stage with Solid Top Plate, 13 mm Travel, 360° Rotation, Metric Taps	\$728.28	Today
OCT-XYR1	XY Stage with Solid Top Plate, 1/2" Travel, 360° Rotation, Imperial Taps	\$728.28	Today

