



COVEGA

Products & Services Catalog 2008

For the latest updates, news & products
visit us on the web:

www.covega.com

Please visit our web for the latest product catalog download.

COVEGA Corporation

10335 Guilford Road, Jessup, MD 20794, USA

Main: +1 240.456.7100 Sales: +1 877.226.8342 Fax: +1 240.456.7200

Contact: info@covega.com Web: www.covega.com

Table of Contents

About Covega	2
Lithium Niobate External Optical Modulators and Integrated Modules	4
Indium Phosphide Laser and Optical Amplifier Products	4
Foundry Services	5
Lithium Niobate Foundry Services.....	5
Indium Phosphide Foundry Services	6
Lithium Niobate Products	7
Mach-10™ 002: Zero-Chirp Intensity Modulator.....	8
Mach-10™ 056: Zero-Chirp Intensity Modulator with integrated PD	10
Mach-10™ 063: - 0.7 Fixed-Chirp Intensity Modulator with integrated Photodetector.....	12
Mach-10™ 053/065: 10G Phase Modulator.....	14
Mach-10™ 083: - 0.7 Fixed-Chirp Intensity Modulator integrated with Variable Optical Attenuator.....	16
Mach-20™ 035: Zero-Chirp Intensity Modulator with integrated PD	18
Mach-LN™ 058: Low $V\pi$ Analog Modulator	20
Mach-40™ 005: 40 Gb/s Fixed Chirp Intensity Modulator with external DC Bias.....	22
Mach-40™ 027/066: 40 Gb/s Phase Modulator	24
Mach-40™ 085: 40 Gb/s Fixed Chirp Intensity Modulator with DC Bias and integrated PD.....	26
Mach-10™ 060: Dual Parallel Modulator.....	28
Mach-10™ 081: Zero-Chirp Intensity Modulator with integrated PD using Field Replaceable GPO Connector	30
Mach-10™ 082: Fixed-Chirp Intensity Modulator with integrated PD using Field Replaceable GPO Connector	32
Indium Phosphide Products	35
BOA 1004: C-band Booster Optical Amplifier	36
BOA 1007: C-band Booster Optical Amplifier Chip.....	38
BOA 1017: O-band Booster Optical Amplifier.....	Error! Bookmark not defined.
SOA 1013: 1550nm C-band Semiconductor Optical Amplifier.....	Error! Bookmark not defined.
SOA 1117: 1550nm Semiconductor Optical Amplifier, Non-Linear	Error! Bookmark not defined.
FPL 1001: 1550nm Fabry-Perot Laser Chip.....	54
FPL 1009: 1550nm Fabry-Perot Laser	56
SAF 1126: C-band Single Angled Facet Gain Chip	58
SAF 1027: C-band Single Angled Facet Reflective Amplifier	60
SAF 1118: L-band Single Angled Facet Gain Chip.....	62
SAF 1120: 1590nm Single Angled Facet Reflective Amplifier.....	64
BAL 1113: 1450nm / 0.5W Broad Area Laser Diode Chip.....	66
BAL 1114: 1450nm / 1.0W Broad Area Laser Diode Chip.....	68
BAL 1115: 1600nm / 0.5W Broad Area Laser Diode Chip.....	70
BAL 1116: 1600nm / 1.0W Broad Area Laser Diode Chip.....	72
SLD 1123: 1280nm / 1mW Super Luminescent Diode	74
SLD 1023: 1280nm / 10mW Super Luminescent Diode	76
SLD 1029: 1280nm / 10mW Super Luminescent Diode	78
SLD 1105: 1310 nm / 5mW Super Luminescent Diode	80
SLD 1021: 1310nm / 10mW Super Luminescent Diode	82
SLD 1024: 1310nm / 15mW Super Luminescent Diode	84
SLD 1018: 1310nm / 15mW Super Luminescent Diode	86
SLD 1128: 1550nm / 1mW Super Luminescent Diode	88
SLD 1108: 1550nm / 2mW Super Luminescent Diode	90
SLD 1030: 1550nm / 10mW Super Luminescent Diode	92
SLD 1005: 1550nm / 15mW Super Luminescent Diode	94
Miscellaneous	97
LDC 1300: Laser Diode Controller - for FPL, BOA, SOA and SLD in Butterfly & DIL Packages.....	98
Fibertail Options for InP Products	100
Fibertail Options for InP Products	101
Legal	103
Covega Corporation Terms & Conditions for the Sale of Covega Products & Services	104

About Covega

Company

Covega Corporation, a leading provider of opto-electronic components and subsystems, was formed in March 2003 from the merger of CODEON Corp. and Quantum Photonics, Inc.. Today,



Covega Corporation
10335 Guilford Road, Jessup, MD 20794, USA
Phone: +1 877.226.8342 **Fax:** +1 240.456.7200
Email: sales@covega.com **Web:** <http://www.covega.com>

Covega caters to a wide range of industries including telecom, datacom, cablecom, defense, medical, industrial, sensing, test & measurement and instrumentation. Covega's products set industry standards for high performance and reliability at low cost. A high level of product integration offers reduction in cost and complexity for systems integrators.

Customers

The company caters to a diverse customer base by offering a broad product portfolio encompassing a comprehensive range of applications. Utilizing monolithic and hybrid integration technologies to create highly functional components and modules, Covega enables its customers to dramatically simplify design and manufacturing of their systems.

Covega's international customer base includes predominantly module, sub-system and systems integrators and at the end of last year, Covega counted worldwide over sixty customers.

Products

Leveraging advanced Lithium Niobate and Indium Phosphide device and packaging technologies, Covega's broad product offering includes Lithium Niobate amplitude and phase modulators as well as Indium Phosphide semiconductor optical amplifiers, gain chips, super luminescent diodes, broad area lasers and high power Fabry-Perot lasers.

Quality & Reliability

All Covega products released for general availability are 100% compliant with the appropriate industry reliability standards. In most cases, this standard is Telcordia GR-468. Covega was the first to fully GR-468 Telcordia qualify a high-speed (12.5 Gb/s) integrated opto-electronic Lithium Niobate modulator- drive amplifier-controller module, a feat not yet achieved by some manufacturers.

Intellectual Property

Covega holds a large intellectual property portfolio of over twenty granted patents and has many more patents pending. The patents granted enable:

- Novel high-speed and high power designs
- Leading edge modulation solutions
- Low-cost hermetic packaging
- Monolithic integration

Product Overview

COVEGA's products include Indium Phosphide & Lithium Niobate optoelectronic products boosting high performance, compact size and high reliability. Packaging options include bare chips, components, modules and sub-systems to meet the needs of various customers and their applications

Lithium Niobate External Optical Modulators and Integrated Modules

- Small Form Factor 10 Gb/s NRZ modulator for TDM and DWDM applications
- M-Series Integrated Transport Module providing turnkey modulation for data rates up to 12.5 Gb/s
- 10G Modulators for Optical RZ or Electrical RZ transmission
- Linearized modulators for CATV applications
- NRZ modulators for 40 Gb/s applications
- 10 and 40 GHz Phase modulators
- DQPSK modulator for transmission up to 40 Gb/s

Indium Phosphide Laser and Optical Amplifier Products

InP Semiconductor Laser Products

- Fabry-Perot Lasers (FPL) at 1550 nm with high power
- Single Angle Facet (SAF) gain chips and modules with wide bandwidth
- Super Luminescent Diodes (SLD) at 1300nm and 1550nm with high power and wide near Gaussian bandwidth
- Broad Area Lasers (BAL) at 1450nm and 1600nm with high power of 0.5W and 1.0W

InP Semiconductor Optical Amplifiers

- Booster Optical Amplifiers (BOA) at 1310nm and 1550nm with high saturation power and wide bandwidth
- Semiconductor Optical Amplifiers (SOA) at 1310nm and 1550nm with high saturation power and wide bandwidth

Foundry Services

Covega's state-of-the-art fully integrated fabrication facility is a 5900 sqft Class 100 / 1000 clean room running standard optoelectronic Indium Phosphide & Lithium Niobate processes and is fully capable of custom process integration to satisfy a wide range of customer needs and requirements.

Lithium Niobate Foundry Services

- R&D, small, medium and high volumes
- Device layout / mask generation
- 4" wafer single or batch processing
- Failure Analysis

Wafer processing capabilities:

- Photolithography (5x Stepper - 0.65 micron or Contact Lithography – 1.0 micron)
- PECVD Deposition – Oxide / Nitride / Oxynitride
- Sputter deposition – Ti, Au, SiO₂
- Furnace oxidation, diffusion, anneal, and cure
- Resist strip - wet and dry processes
- Wet etch chemistries for SiO₂, Au, Ti, InP / GaAs
- Lap & polish
- Saw and facet polish
- On-wafer parametric tests

Die mounting capabilities:

- Die attach
- Wire Bond

Indium Phosphide Foundry Services

- R&D, small, medium and high volumes
- Device layout / mask generation
- Molecular Beam Epitaxy (MBE) of 2" & 3" InP wafers
- Single or batch processing of 2" & 3" InP wafers
- Die attach & test
- Hermetic packaging & test
- Failure Analysis

Wafer processing capabilities:

- Photolithography (5x Stepper - 0.65 micron or Contact Lithography – 1.0 micron)
- RIE Dielectric Etch – Oxide / Nitride / Oxynitride / SOG / Si / Ti
- RIE Semiconductor Etch – InP / InGaAs / InGaAsP
- PECVD Deposition – Oxide / Nitride / Oxynitride
- Metallization – Au, Pt, Ti, Ni, & Ge
- Rapid thermal anneal (RTA)
- Furnace oxidation, diffusion, anneal, and cure
- Planarization technology
- Resist strip - wet and dry processes
- Wet etch chemistries for SiO₂, Au, Ti, InP / GaAs
- Lap & polish
- Cleave and dice
- Pick and place
- Optical and facet AR & HR coating
- On-wafer parametric tests

Die mounting capabilities:

- Die attach
- Wire bond
- Standard / custom COS
- Heatsink
- C/CT- mount
- COS - tests

Packaging capabilities:

- Standard 14-pin Butterfly with SMF / PMF, isolator options
- Standard 14-pin DIL with SMF, photodiode options
- Final test of packages



Covega Corporation
10335 Guilford Road, Jessup, MD 20794, USA
Phone: +1 877.226.8342 **Fax:** +1 240.456.7200
Email: sales@covega.com **Web:** <http://www.covega.com>

Lithium Niobate Products

Mach-10™ 002: Zero-Chirp Intensity Modulator

7.1.2.SP.0002 Rev C

Description

COVEGA's Zero-Chirp Intensity Modulator is part of the Mach-10™ product line, a family of high performance, Telcordia compliant external optical modulators with industry leading long-term stability. The Zero-Chirp Intensity Modulator is available with up to 12.0 GHz bandwidth (at -3 dB) for customers requiring greater bandwidth to implement today's most demanding FEC schemes such as Super FEC and Digital Wrapper (G.709). The Zero-Chirp Intensity Modulator is based on the Mach-Zehnder interferometric architecture, using titanium-indiffused lithium niobate substrates and is available bias trimmed for near-zero volt operation at quadrature, or any operating point.



Features

Applications

- ✓ High-Speed Data Communications
 - SONET OC-192 Interfaces
 - SDH STM-64 Interfaces
 - WDM transmission at +10 Gb/s
- ✓ Undersea communications
- ✓ Internet router interfaces
- ✓ High-speed test equipment

- Superior Frequency Performance
- Zero-Chirp
- Long-Term Bias Stability
- Hermetic Packaging
- High Reliability – Telcordia GR-468 Compliant
- C & L Band Operation

Ordering Information

Mach-10 002-XX-X-X-X-XX

Part #	Bandwidth	Output Fiber Type	Input Connector	Output Connector	Bias Operating Point	
002	10 = 10 GHz*	S = SMF*	S = SC/PC*	S = SC/PC*	PS = Positive Slope	
	12 = 12 GHz	P = PMF	B = Bare Fiber	B = Bare Fiber	NS = Negative Slope*	
			F = FC/uPC	F = FC/uPC	PK = Peak	
			L = LC/PC	L = LC/PC	NL = Null	
			A = FC/aPC	A = FC/aPC		
			M = Mu	M = Mu		

* Default options unless otherwise specified

Mach-10™ 002

Specifications

Parameter		Min	Typ	Max	
Operating Case Temperature	T_{CASE}	0		70	C
Operating Wavelength	λ	1525		1605	nm
Optical Insertion Loss (Connectorized)	I.L.		4.0	5.0	dB
Insertion Loss Variation (EOL)	$\Delta I.L.$	-0.5		0.5	dB
Modulator Chirp Parameter	α	-0.1		0.1	
Optical Return Loss		40			dB
Optical On/Off Extinction Ratio (@ DC)	E.R.	20			dB
Optical Extinction Ratio (PRBS)	E.R.	13			dB
Bit Rate Frequency	f_{BR}	9.953		12.5	Gb/s
E/O Bandwidth (-3 dB with Linear Fit)	f_{C-3dB}	10.0/12.0			GHz
S11 (dc to 10 GHz)			-12	-10	dB
RF Drive Voltage (PRBS)	V_{PRBS}		6.0	6.5	V
Vpi RF Port (@ 1GHz)	V_{RF}		5.2		V
Vpi Bias Port (@ DC)				9	V
DC Bias Voltage Range (EOL)	V_{BIAS}	-8		8	V

SPECIFICATIONS ARE SUBJECT TO CHANGE WITHOUT NOTICE

Packaging

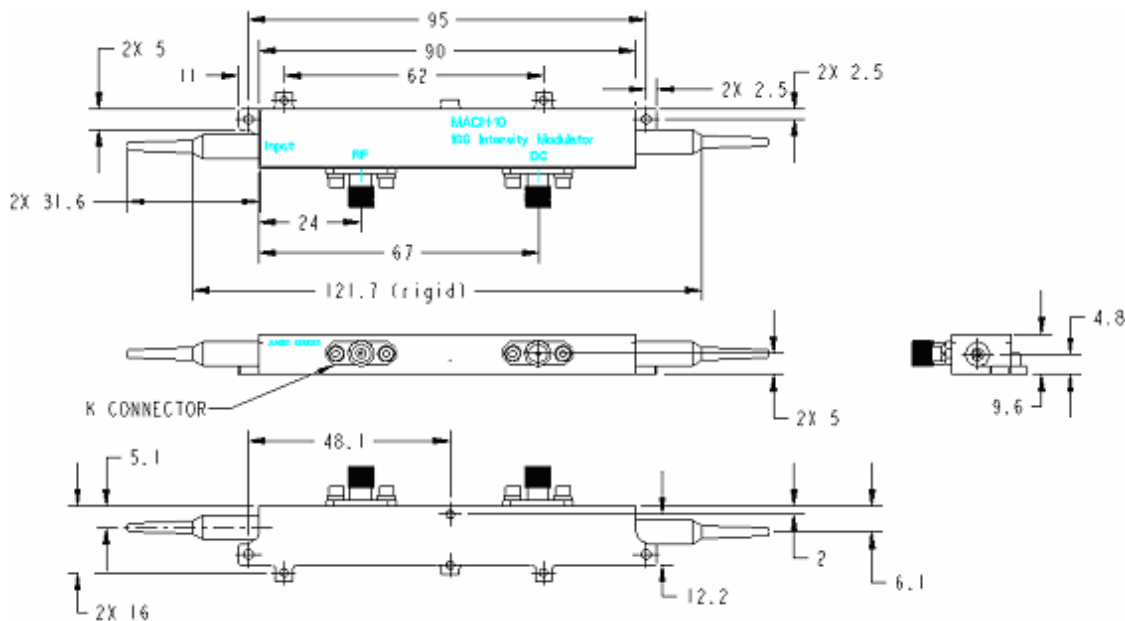

Dimensions in mm unless otherwise specified; Tolerances are ± 0.05 (decimals) ± 1 (angles)

Mach-10™ 056: Zero-Chirp Intensity Modulator with integrated PD

7.1.2.SP.0056 Rev D

Description

The Mach-10™ Zero-Chirp Intensity Modulator with Integrated Photodetector was designed for customers seeking small form-factor modulators with increased bandwidth for FEC implementation; supporting data rates from 9.953 Gb/s to 12.5 Gb/s. The Zero-Chirp Intensity Modulator with Integrated Photodetector is based on Titanium-indiffused x-cut Lithium Niobate and uses a Mach-Zehnder interferometric architecture. Designed for integration into 300 pin MSA compatible transponders, it is ideal for metro and long-haul DWDM applications requiring less than a 2 dB power penalty for +/-1,200 ps/nm dispersion.

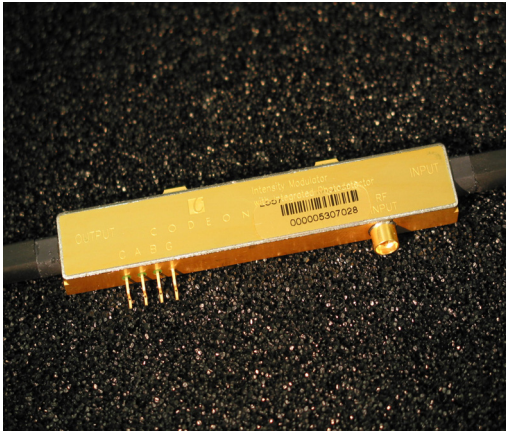

The integrated photodetector can be used for optical power monitoring and modulator bias control, eliminating the need for an external fiber tap and splicing. The extremely small footprint and low profile make it ideal for customers seeking to reduce the size of their current 300 pin MSA compatible metro or long-haul transponder platforms. The Zero-Chirp Intensity Modulator with Integrated Photodetector is a single-ended drive configuration.

Applications

- ✓ High-Speed Data Communications
 - SONET OC-192 Interfaces
 - SDH STM-64 Interfaces
 - WDM transmission at +10 Gb/s
- ✓ Undersea Communications
- ✓ Internet Router Interfaces
- ✓ High-speed test equipment

Features

- Superior Frequency Performance
- Small Size – 300 pin MSA Transponder Compatible Footprint
- Low Drive Voltage
- Long-Term Bias Stability
- Hermetic Packaging - High Reliability - Telcordia GR-468 Compliant
- Integrated Photodetector
- C & L Band Operation

Ordering Information

Mach-10 056-XX-X-X-X-XX						
Part #	Bandwidth	Output Fiber Type	Input Connector	Output Connector	Bias Operating Point	Pin Leads
056	10 = 10 GHz*	S = SMF*	S = SC/PC*	S = SC/PC*	PS = Pos. Slope	BNL = Bent*
	12 = 12 GHz	P = PMF	B = Bare Fiber	B = Bare Fiber	NS = Neg. Slope*	STL = Straight
			F = FC/uPC	F = FC/uPC	PK = Peak	
			L = LC/PC	L = LC/PC	NL = Null	
			A = FC/aPC	A = FC/aPC		
			M = Mu	M = Mu		
* Default options unless otherwise specified						

Mach-10™ 056

Specifications

Parameter		Min	Typ	Max	
Operating Case Temperature	T_{CASE}	0		70	C
Operating Wavelength	λ	1525		1605	nm
Optical Insertion Loss (Connectorized)	I.L.		4.0	5.0	dB
Insertion Loss Variation (EOL)	$\Delta I.L.$	-0.5		0.5	dB
Modulator Chirp Parameter	α	-0.1		0.1	
Optical Return Loss		40			dB
Optical On/Off Extinction Ratio (@ DC)	E.R.	20			dB
Optical Extinction Ratio (PRBS)	E.R.	13			dB
Bit Rate Frequency	f_{BR}	9.953		12.5	Gb/s
E/O Bandwidth (-3 dB with Linear Fit)	f_{C-3dB}	10.0/12.0			GHz
S11 (dc to 10 GHz)			-12	-10	dB
RF Drive Voltage (PRBS)	V_{PRBS}		5.5	6	V
Vpi Bias Port (@ DC)				8	V
DC Bias Voltage Range (EOL)	V_{BIAS}	-8		8	V
PD Responsivity (ref. to output power)		0.1		0.5	mA/mW
Output Optical Power Monitoring Range		-5		10	dBm
Output Monitor Variation		-0.5		0.5	dB
Monitor Photodiode Reverse Bias Voltage		-5.5		-3.0	V

SPECIFICATIONS ARE SUBJECT TO CHANGE WITHOUT NOTICE

Packaging

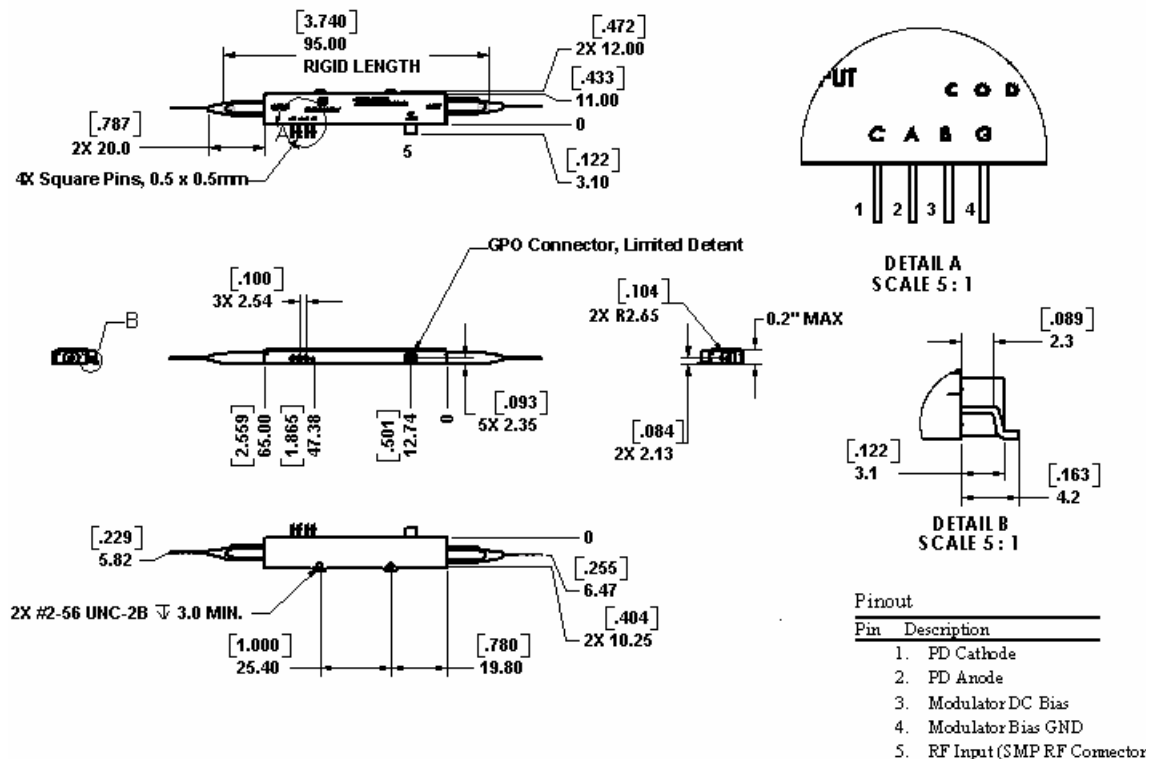

Dimensions in mm unless otherwise specified; Tolerances are ± 0.05 (decimals) ± 1 (angles)

Mach-10™ 063: - 0.7 Fixed-Chirp Intensity Modulator with integrated Photodetector

7.1.2.SP.0063 Rev C

Description

The Mach-10™ Zero-Chirp Intensity Modulator with Integrated Photodetector was designed for customers seeking small form-factor modulators with increased bandwidth for FEC implementation; supporting data rates from 9.953 Gb/s to 12.5 Gb/s. The Fixed-Chirp Intensity Modulator with Integrated Photodetector is based on Titanium-indiffused z-cut Lithium Niobate and uses a Mach-Zehnder interferometric architecture. Designed for integration into 300 pin MSA compatible transponders, it is ideal for metro and long-haul applications requiring improved power penalty performance over Zero-Chirp devices; less than 2 dB for +1,600 ps/nm dispersion.

The integrated photodetector can be used for optical power monitoring and modulator bias control, eliminating the need for an external fiber tap and splicing. The extremely small footprint makes it ideal for customers seeking to reduce the size of their current 300 pin MSA transponder platforms. The 063 Modulator is a single-ended drive configuration with separate DC Bias pins, pin-for-pin compatible with COVEGA's Zero-Chirp Intensity Modulator (056).

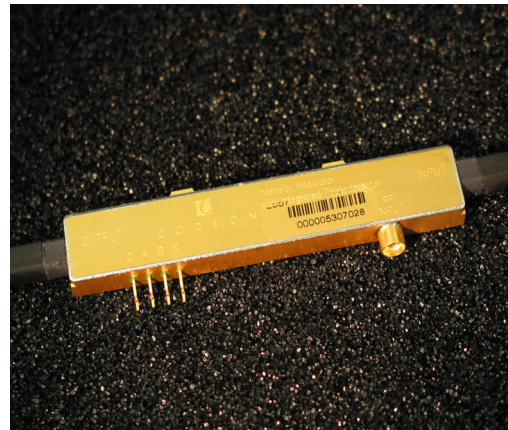

Features

- Superior Frequency Performance
- Small Size – 300 pin MSA Transponder Compatible Footprint
- Low Drive Voltage
- Long-Term Bias Stability
- Hermetic Packaging - High Reliability - Telcordia GR-468 Compliant
- Integrated Photodetector
- C & L Band Operation

Applications

- ✓ High-Speed Data Communications
 - SONET OC-192 Interfaces
 - SDH STM-64 Interfaces
 - WDM transmission at +10 Gb/s
- ✓ Undersea Communications
- ✓ Internet Router Interfaces
- ✓ High-speed test equipment

Ordering Information

Mach-10 063-XX-X-X-X-NS-XXX

Part #	Bandwidth	Output Fiber Type	Input Connector	Output Connector	Bias Operating Point	Pin Leads
063	10 = 10 GHz*	S = SMF*	S = SC/PC*	S = SC/PC*	NS = Neg. Slope*	BNL = Bent*
	12 = 12 GHz	P = PMF	B = Bare Fiber	B = Bare Fiber		STL = Straight
			F = FC/uPC	F = FC/uPC		
			L = LC/PC	L = LC/PC		
			A = FC/aPC	A = FC/aPC		
			M = Mu	M = Mu		

* Default options unless otherwise specified

Mach-10™ 063

Specifications

Parameter		Min	Typ	Max	
Operating Case Temperature	T_{CASE}	0		70	C
Operating Wavelength	λ	1525		1605	nm
Optical Insertion Loss (Connectorized)	I.L.		4.0	5.0	dB
Insertion Loss Variation (EOL)	$\Delta I.L.$	-0.5		0.5	dB
Modulator Chirp Parameter	$ \alpha $	0.6		0.8	
Optical Return Loss		40			dB
Optical On/Off Extinction Ratio (@ DC)	E.R.	20			dB
Optical Extinction Ratio (PRBS)	E.R.	13			dB
Bit Rate Frequency	f_{BR}	9.953		12.5	Gb/s
E/O Bandwidth (-3 dB with Linear Fit)	f_{C-3dB}	10.0/12.0			GHz
S11 (dc to 10 GHz)			-12	-10	dB
RF Drive Voltage (PRBS)	V_{PRBS}		5.5	6	V
Vpi Bias Port (@ DC)			3.0	8	V
DC Bias Voltage Range (EOL)	V_{BIAS}	-8		8	V
PD Responsivity (ref. to output power)		0.1		0.5	mA/mW
Output Optical Power Monitoring Range		-5		10	dBm
Output Monitor Variation		-0.5		0.5	dB
Monitor Photodiode Reverse Bias Voltage		-5.5		-3.0	V

SPECIFICATIONS ARE SUBJECT TO CHANGE WITHOUT NOTICE

Packaging

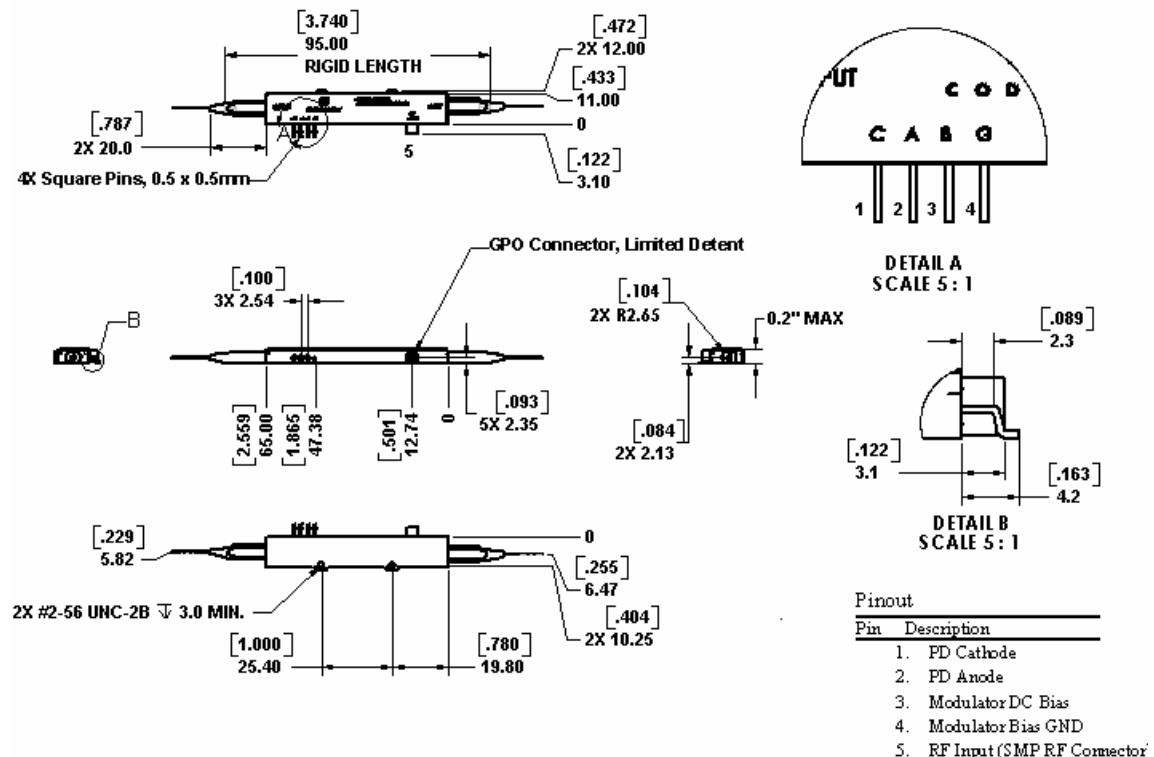

Dimensions in mm unless otherwise specified; Tolerances are ± 0.05 (decimals) ± 1 (angles)

Mach-10™ 053/065: 10G Phase Modulator

7.1.2.SP.0053 Rev C

Description

COVEGA's Phase Modulator was designed for customers seeking low optical loss, low drive voltage and a small form-factor. The increased bandwidth allows for chirp control in high-speed data communications; supporting data rates from 9.953 Gb/s to 12.5 Gb/s. The modulator is also ideal for applications in coherent communications, sensing, all-optical frequency-shifting, and data encryption.

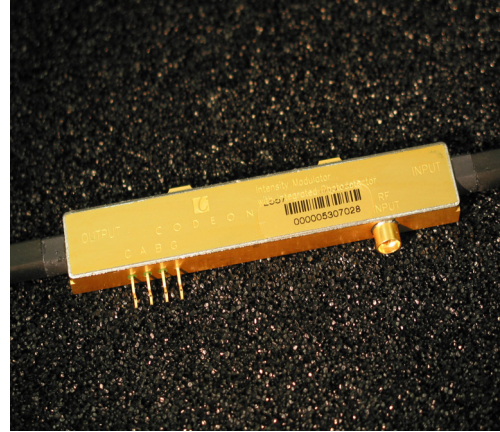

The Phase Modulator is based on Titanium-indiffused z-cut Lithium Niobate. For ease of system integration it is offered with internal termination and optional polarization-maintaining output fiber. This device is available with, or without, an internal optical polarizer positioned at the device output.

Features

Applications

- ✓ Chirp control for high-speed data communications
- ✓ Coherent communications
- ✓ Optical sensors
- ✓ All-optical frequency shifting

- Superior Frequency Performance
- Small Size
- Low Drive Voltage
- Low Loss
- C & L Band Operation
- Internal Termination and Optional Polarizer

Ordering Information

Mach-10 053/065-10-X-X-X-XXX

Part #	Bandwidth	Output Fiber Type	Input Connector	Output Connector	Pin Leads
065 = with optical polarizer	10 = 10 GHz	S = SMF*	S = SC/PC*	S = SC/PC*	BNL = Bent*
053 = without optical polarizer		P = PMF	B = Bare Fiber	B = Bare Fiber	STL = Straight
			F = FC/uPC	F = FC/uPC	
			L = LC/PC	L = LC/PC	
			A = FC/aPC	A = FC/aPC	
			M = Mu	M = Mu	

* Default options unless otherwise specified

Mach-10™ 053/065

Specifications

Parameter		Min	Typ	Max	
Operating Case Temperature	T_{CASE}	0		70	C
Operating Wavelength	λ	1525		1605	nm
Optical Insertion Loss (Connectorized)	I.L.		3.5	4.5	dB
Insertion Loss Variation (EOL)	$\Delta I.L.$	-0.5		0.5	dB
Optical Return Loss		40			dB
Bit Rate Frequency	f_{BR}	9.953		12.5	Gb/s
E/O Bandwidth (-3 dB with Linear Fit)	f_{c-3dB}	10.0/12.0			GHz
S_{11} (dc to 10 GHz)			-12	-10	dB
RF Drive Voltage (PRBS)	V_{PRBS}		4.5	5	V
V_{π} (@ DC)			3.5	4	V

SPECIFICATIONS ARE SUBJECT TO CHANGE WITHOUT NOTICE

Packaging

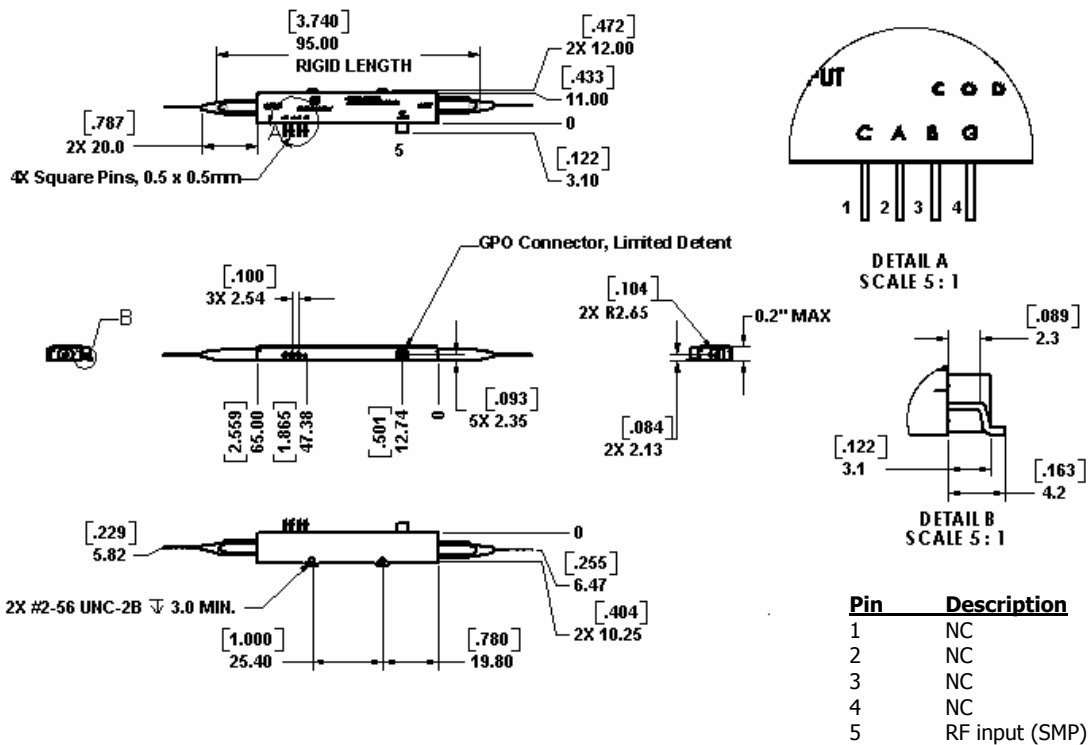

Dimensions in mm unless otherwise specified; Tolerances are ± 0.05 (decimals) ± 1 (angles)

Mach-10™ 083: - 0.7 Fixed-Chirp Intensity Modulator integrated with Variable Optical Attenuator

7.1.2.SP.0083 Rev B

Description

The Intensity Modulator with Integrated Variable Optical Attenuator was designed for customers seeking higher levels of integration for today's high-speed fiber optic telecommunication systems. Designed for multi-channel WDM transmission, the integrated Variable Optical Attenuator allows dynamic channel equalization by enabling active attenuation of optical output power. This flexibility allows the efficient management of network imbalances in DWDM optical links. The Intensity Modulator with Variable Optical Attenuator supports data rates up to 12.5 Gb/s and has an active attenuation range greater than 15 dB.

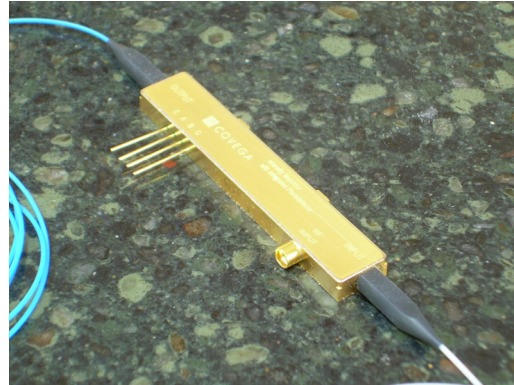

The Intensity Modulator with Variable Optical Attenuator is a "fixed chirp", single-ended drive configuration, modulator based on the Mach-Zehnder interferometric architecture, using titanium-indiffused lithium niobate substrates.

Applications

- ✓ High-Speed Data Communications
 - SONET OC-192 Interfaces
 - SDH STM-64 Interfaces
 - WDM transmission at +10 Gb/s
- ✓ Undersea communications
- ✓ Internet router interfaces
- ✓ High-speed test equipment

Features

- Superior Frequency Performance
- Integrated Variable Optical Attenuator
- Zero-Chirp
- Low Drive Voltage
- Long-Term Bias Stability
- Hermetic Packaging - High Reliability - Telcordia GR-468 Compliant
- C & L Band Operation

Ordering Information

Mach-10 083-XX-X-X-X-XX						
Part #	Bandwidth	Output Fiber Type	Input Connector	Output Connector	Bias Operating Point	Pin Leads
083	10 = 10 GHz*	S = SMF*	S = SC/PC*	S = SC/PC*		BNL = Bent*
	12 = 12 GHz	P = PMF	B = Bare Fiber	B = Bare Fiber	NS = Negative Slope*	STL = Straight
			F = FC/uPC	F = FC/uPC		
			L = LC/PC	L = LC/PC		
			A = FC/aPC	A = FC/aPC		
			M = Mu	M = Mu		

* Default options unless otherwise specified

Mach-10™ 083

Specifications

Parameter		Min	Typ	Max	
Operating Case Temperature	T_{CASE}	0		70	C
Operating Wavelength	λ	1525		1605	nm
Optical Insertion Loss (Connectorized)	I.L.		4.0	5.5	dB
Insertion Loss Variation (EOL)	$\Delta I.L.$	-0.5		0.5	dB
Modulator Chirp Parameter	α	-0.6		-0.8	
Optical Return Loss		40			dB
Optical On/Off Extinction Ratio (@ DC)	E.R.	20			dB
Optical Extinction Ratio (PRBS)	E.R.	13			dB
Bit Rate Frequency	f_{BR}	9.953		12.5	Gb/s
E/O Bandwidth (-3 dB with Linear Fit)	f_{C-3dB}	10.0/12.0			GHz
S11 (dc to 10 GHz)			-12	-10	dB
RF Drive Voltage (PRBS)	V_{PRBS}		6.5	7.0	V
Vpi RF Port (@ 1GHz)	V_{RF}		6.5	7.5	V
Vpi Bias Port (@ DC)			6.0	7	V
DC Bias Voltage Range (EOL)	V_{BIAS}	-10		10	V
Attenuation Range		15			dB
V_{π} Attenuator Port (@ DC)				18	V
VOA Control Voltage Range (EOL)	V_{BIAS}	-16		16	V

Packaging

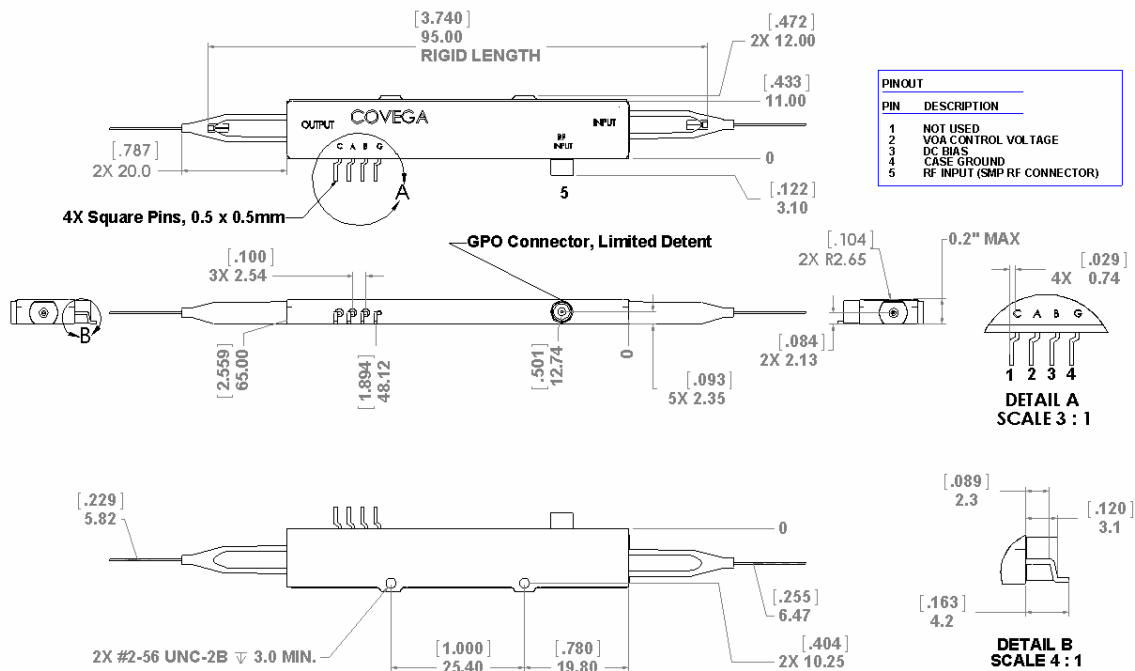

Dimensions in mm unless otherwise specified; Tolerances are $\pm 0.1\text{mm} \pm 1$ (angles)

Mach-20™ 035: Zero-Chirp Intensity Modulator with integrated PD

7.1.2.SP.0035 Rev A

Description

The Mach-10™ Zero-Chirp Intensity Modulator with Integrated Photodetector was designed for customers seeking small form-factor modulators with increased bandwidth for FEC implementation; supporting data rates from 9.953 Gb/s to 12.5 Gb/s. The Zero-Chirp Intensity Modulator with Integrated Photodetector is based on Titanium-indiffused x-cut Lithium Niobate and uses a Mach-Zehnder interferometric architecture. Designed for integration into 300 pin MSA compatible transponders, it is ideal for metro and long-haul DWDM applications requiring less than a 2 dB power penalty for +/-1,200 ps/nm dispersion.

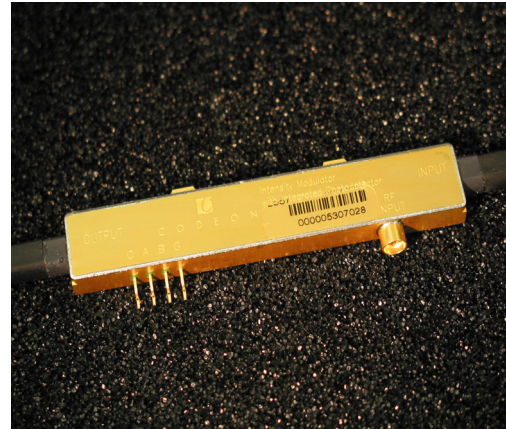

The integrated photodetector can be used for optical power monitoring and modulator bias control, eliminating the need for an external fiber tap and splicing. The extremely small footprint and low profile make it ideal for customers seeking to reduce the size of their current 300 pin MSA compatible metro or long-haul transponder platforms. The Zero-Chirp Intensity Modulator with Integrated Photodetector is a single-ended drive configuration.

Applications

- ✓ High-Speed Data Communications
 - SONET OC-192 Interfaces
 - SDH STM-64 Interfaces
 - WDM transmission at +10 Gb/s
- ✓ Undersea Communications
- ✓ Internet Router Interfaces
- ✓ High-speed test equipment

Features

- Superior Frequency Performance
- Small Size – 300 pin MSA Transponder Compatible Footprint
- Low Drive Voltage
- Long-Term Bias Stability
- Hermetic Packaging - High Reliability - Telcordia GR-468 Compliant
- Integrated Photodetector
- C & L Band Operation

Ordering Information

Mach-20 035-XX-X-X-X-XX						
Part #	Bandwidth	Output Fiber Type	Input Connector	Output Connector	Bias Operating Point	Pin Leads
056	18 = 18 GHz*	S = SMF*	S = SC/PC*	S = SC/PC*	PS = Pos. Slope	BNL = Bent*
		P = PMF	B = Bare Fiber	B = Bare Fiber	NS = Neg. Slope*	STL = Straight
			F = FC/uPC	F = FC/uPC	PK = Peak	
			L = LC/PC	L = LC/PC	NL = Null	
			A = FC/aPC	A = FC/aPC		
			M = Mu	M = Mu		
* Default options unless otherwise specified						

Mach-20™ 035

Specifications

Parameter		Min	Typ	Max	
Operating Case Temperature	T_{CASE}	0		70	C
Operating Wavelength	λ	1525		1605	nm
Optical Insertion Loss (Connectorized)	I.L.		4.0	5.0	dB
Insertion Loss Variation (EOL)	$\Delta I.L.$	-0.5		0.5	dB
Modulator Chirp Parameter	α	-0.1		0.1	
Optical Return Loss		40			dB
Optical On/Off Extinction Ratio (@ DC)	E.R.	20			dB
Optical Extinction Ratio (PRBS)	E.R.	13			dB
Bit Rate Frequency	f_{BR}	9.953		12.5	Gb/s
E/O Bandwidth (-3 dB with Linear Fit)	f_{C-3dB}	18	19.5		GHz
S11 (dc to 10 GHz)			-12	-10	dB
RF Drive Voltage (PRBS)	V_{PRBS}		6.0	6.5	V
Vpi Bias Port (@ DC)				8	V
DC Bias Voltage Range (EOL)	V_{BIAS}	-8		8	V
PD Responsivity (ref. to output power)		0.1		0.5	mA/mW
Output Optical Power Monitoring Range		-5		10	dBm
Output Monitor Variation		-0.5		0.5	dB
Monitor Photodiode Reverse Bias Voltage		-5.5		-3.0	V

SPECIFICATIONS ARE SUBJECT TO CHANGE WITHOUT NOTICE

Packaging

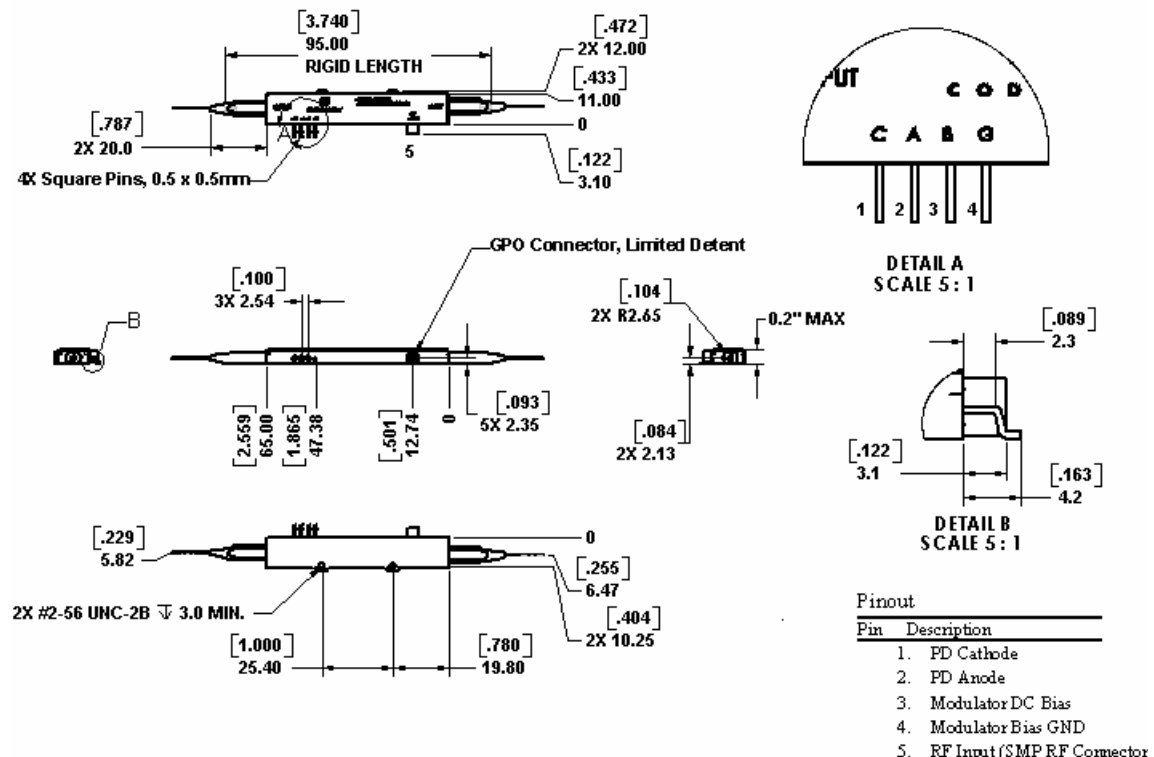

Dimensions in mm unless otherwise specified; Tolerances are ± 0.05 (decimals) ± 1 (angles)

Mach-LN™ 058: Low V_{π} Analog Modulator

7.1.2.SP.0058 Rev D

Preliminary Model

Description

The Low V_{π} Intensity Modulator was designed for high performance analog transmission in microwave optical links. Operating frequencies to 20 GHz are supported, with an industry-leading low V_{π} . The Low V_{π} Intensity Modulator is a single-ended drive modulator based on the Mach-Zehnder interferometric architecture, using titanium-indiffused lithium niobate substrates.

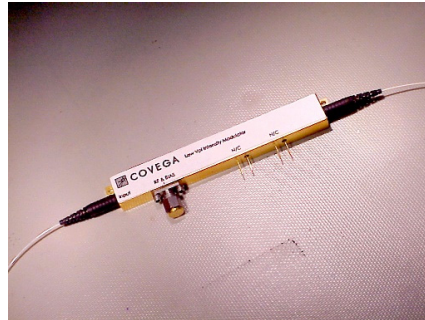

Features

Applications

- ✓ Microwave optical links
- ✓ Antenna remoting
- ✓ High-speed test equipment

- Very Low V_{π} (<3.9V at 20 GHz)
- Excellent Performance to 20 GHz
- Long-Term Bias Stability
- Hermetic Packaging - High Reliability - Telcordia GR-468 Compliant
- C & L Band Operation

Ordering Information

LN 058-20-X-X-X

Part #	Bandwidth	Output Fiber Type	Input Connector	Output Connector
058	20 = 20 GHz	S = SMF*	S = SC/PC*	S = SC/PC*
		P = PMF	B = Bare Fiber	B = Bare Fiber
			F = FC/uPC	F = FC/uPC
			L = LC/PC	L = LC/PC
			A = FC/aPC	A = FC/aPC
			M = Mu	M = Mu

* Default options unless otherwise specified

LN 058

Specifications

Parameter	Min	Typ	Max	
Environmental:				
Operating Case Temperature	0		70	C
Storage Temperature	-40		85	C
Optical:				
Operating Wavelength	1525		1605	nm
Optical Insertion Loss (Connectorized)			5.5	dB
Insertion Loss Variation (EOL)	-0.5		0.5	dB
Optical Return Loss	40			dB
Optical On/Off Extinction Ratio (@ DC)	20			dB
Electrical:				
S11 (dc to 20 GHz)		-12	-10	dB
V_{π} @ 20 GHz		3.5	3.9	V
V_{π} @ DC		1.5	2	V
Mechanical				
RF Connection	SMA Connector			
Bias Connection	Lead Pins			
SPECIFICATIONS ARE SUBJECT TO CHANGE WITHOUT NOTICE				

Packaging

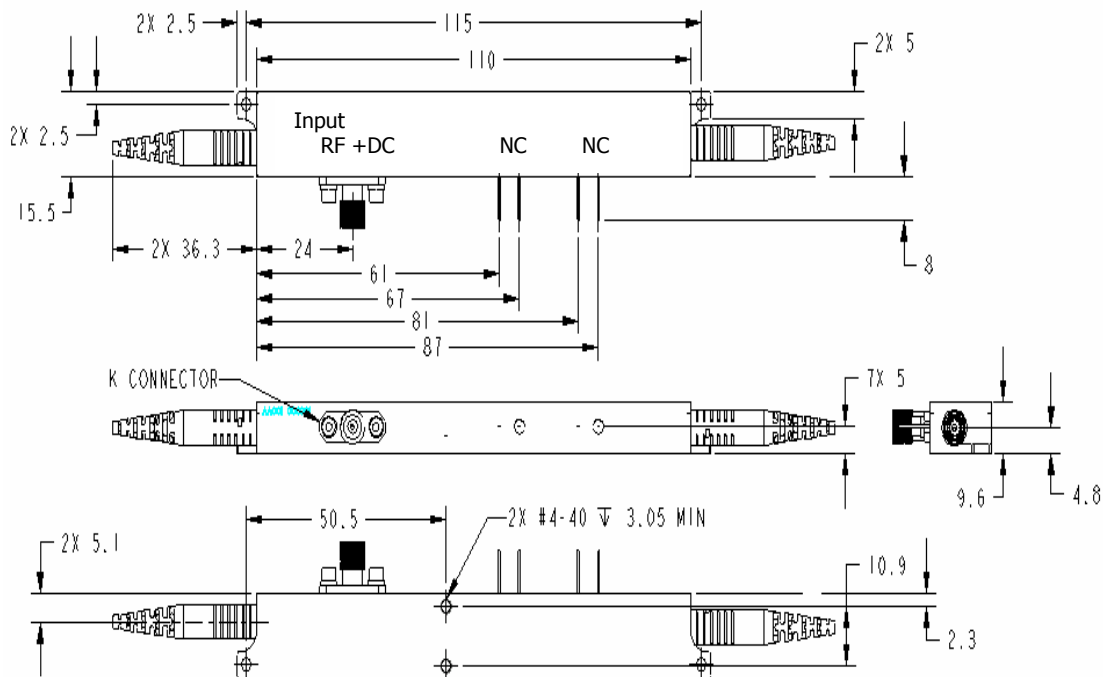

Dimensions in mm unless otherwise specified; Tolerances are ± 0.05 (decimals) ± 1 (angles)
 Device used same housing as Mach10 004, with pin re-assignments

Mach-40™ 005: 40 Gb/s Fixed Chirp Intensity Modulator with external DC Bias

7.1.2.SP.0005 Rev F

Preliminary Model

Description

The 40 Gb/s Intensity Modulator with External DC Bias is a revolutionary, high performance External Optical Modulator designed for customers developing next generation 40G transmission systems. The 40 Gb/s Intensity Modulator with External DC Bias is based on Titanium-indiffused z-cut Lithium Niobate and uses a Mach-Zehnder interferometric architecture. The 40 Gb/s Intensity Modulator has sufficient bandwidth for customers requiring greater bandwidth to implement today's most demanding FEC schemes.

The 40 Gb/s Intensity Modulator with External DC Bias is ideal for both NRZ and RZ data format solutions. The 40 Gb/s Intensity Modulator with External DC Bias is a single-ended drive configuration with a fixed chirp coefficient of +/-0.7 and an industry leading low RF drive voltage.

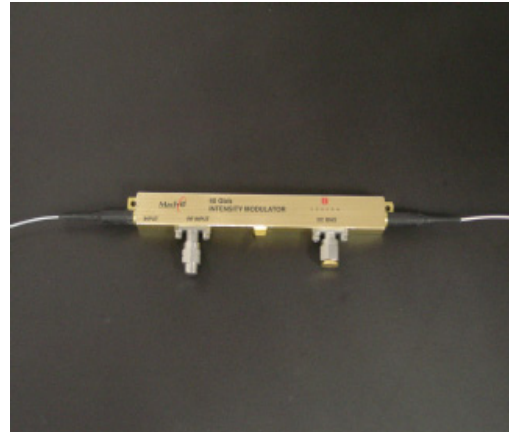

Features

Applications

- ✓ High-Speed Data Communications
 - SONET OC-768 Interfaces
 - SDH STM-256 Interfaces
 - WDM transmission at 40 Gb/s
- ✓ Undersea communications
- ✓ Internet router interfaces
- ✓ High-speed test equipment

- Superior Frequency Performance
- Industry Leading Low Drive Voltage
- Long-Term Bias Stability
- Fixed Non-Zero Chirp
- Hermetic Packaging - High Reliability
- C & L Band Operation

Ordering Information

Mach-40 005-40-X-X-X-NS

Part #	Bandwidth	Output Fiber Type	Input Connector	Output Connector	Bias Operating Point
005	40 = 40 GHz*	S = SMF*	S = SC/PC*	S = SC/PC*	NS = Negative Slope
		P = PMF	B = Bare Fiber	B = Bare Fiber	
			F = FC/uPC	F = FC/uPC	
			L = LC/PC	L = LC/PC	
			A = FC/aPC	A = FC/aPC	
			M = Mu	M = Mu	

* Default options unless otherwise specified

Mach-40™ 005

Specifications

Parameter		Min	Typ	Max	
Operating Case Temperature	T_{CASE}	0		70	C
Operating Wavelength	λ	1525		1605	nm
Optical Insertion Loss (Connectorized)	I.L.		4.5	5.5	dB
Modulator Chirp Parameter	α	-0.6	-0.7	-0.8	
Optical Return Loss		40			dB
Optical On/Off Extinction Ratio (@ DC)	E.R.	20			dB
Optical Extinction Ratio (PRBS)	E.R.		13		dB
Bit Rate Frequency	f_{BR}		40		Gb/s
E/O Bandwidth (-3 dB with Linear Fit re. 130 MHz)	f_{C-3dB}	30	35		GHz
S11 (dc to 30 GHz)			-12	-10	dB
S11 (30 GHz to 40 GHz)			-10	-8	dB
RF Drive Voltage (PRBS)	V_{PRBS}		5.5		V
Vpi RF Port (@ 1GHz)	V_{RF}			4.0	V
Vpi Bias Port (@ DC)				10.0	V
DC Bias Voltage Range (EOL)	V_{BIAS}	-8		8	V
RF Connector	V - Connector				
SPECIFICATIONS ARE SUBJECT TO CHANGE WITHOUT NOTICE					

Packaging

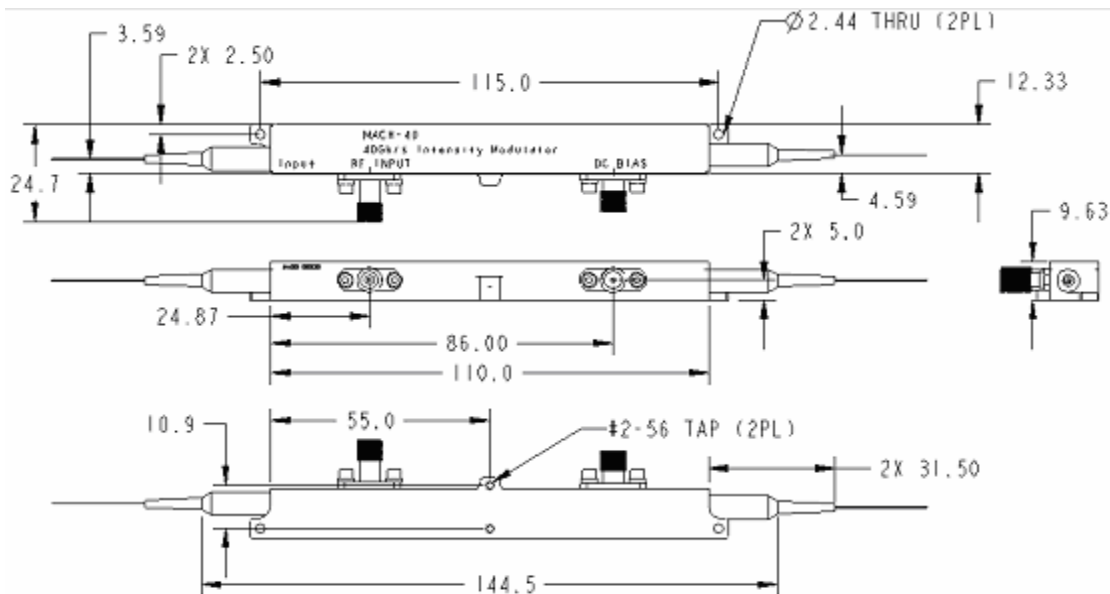

Dimensions in mm unless otherwise specified; Tolerances are ± 0.05 (decimals) ± 1 (angles)

Mach-40™ 027/066: 40 Gb/s Phase Modulator

7.1.2.SP.0027 Rev F

Preliminary Model

Description

The 40 Gb/s Phase Modulator is a high performance, low drive voltage External Optical Modulator designed for customers developing next generation 40G transmission systems. The increased bandwidth allows for chirp control in high-speed data communications; supporting data rates up to 43 Gb/s. The modulator is also ideal for applications in coherent communications, sensing, all-optical frequency-shifting, and data encryption.

The Phase Modulator is based on Titanium-indiffused z-cut Lithium Niobate. For ease of system integration it is offered with internal termination and optional polarization-maintaining output fiber. This device is available with, or without, an internal optical polarizer positioned at the device output.

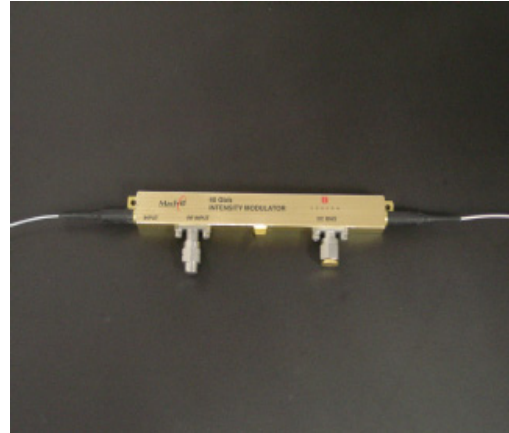

Features

Applications

- ✓ Chirp Control for High-Speed Communications
 - SONET OC-768 Interfaces
 - SDH STM-256 Interfaces
 - WDM transmission at +40 Gb/s
 - ✓ Coherent communications
 - ✓ Optical Sensing
 - ✓ All-optical frequency shifting
- Superior Frequency Performance
 - Low Drive Voltage
 - Internal Termination and Optional Polarizer
 - Hermetic Packaging - High Reliability
 - C & L Band Operation

Ordering Information

Mach-40 027/066-40-X-X-X

Part #	Bandwidth	Output Fiber Type	Input Connector	Output Connector
027 = <i>with optical polarizer</i>	40 = 40 GHz	S = SMF*	S = SC/PC*	S = SC/PC*
066 = <i>without optical polarizer</i>		P = PMF	B = Bare Fiber	B = Bare Fiber
			F = FC/uPC	F = FC/uPC
			L = LC/PC	L = LC/PC
			A = FC/aPC	A = FC/aPC
			M = Mu	M = Mu

* Default options unless otherwise specified

Mach-40™ 027/066

Specifications

Parameter		Min	Typ	Max	
Operating Case Temperature	T_{CASE}	0		70	C
Operating Wavelength	λ	1525		1605	nm
Optical Insertion Loss (Connectorized)	I.L.		4.0	5.0	dB
Insertion Loss Variation (EOL)	$\Delta I.L.$	-0.5		0.5	dB
Optical Return Loss		40			dB
Bit Rate Frequency	f_{BR}		40		Gb/s
E/O Bandwidth (-3 dB with Linear Fit ref. 130 MHz)	f_{c-3dB}	30	35		GHz
S11 (dc to 30 GHz)			-12	-10	dB
S11 (30 GHz to 40 GHz)			-10	-8	dB
Drive Voltage of RF Port (PRBS)	V_{PRBS}		5.5		V
V_{π} RF Port (@ 1GHz)	V_{RF}			4.0	V
RF Connector		V - Connector			

SPECIFICATIONS ARE SUBJECT TO CHANGE WITHOUT NOTICE

Packaging

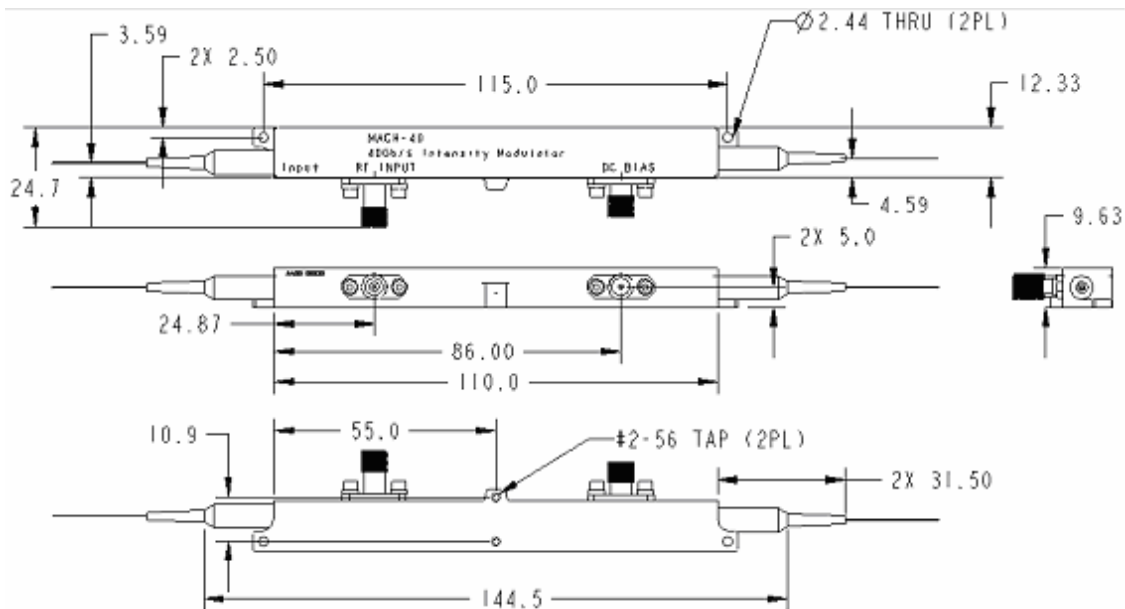

Dimensions in mm unless otherwise specified; Tolerances are ± 0.05 (decimals) ± 1 (angles)
 The 40G Phase Modulator is packaged in the same housing as the 40G Intensity Modulator (shown above).
 However, for Phase Modulator operation the DC Bias port remains unused.

Mach-40™ 085: 40 Gb/s Fixed Chirp Intensity Modulator with DC Bias and integrated PD

7.1.2.SP.0085 Rev A

Limited Availability

Description

The 40 Gb/s Intensity Modulator with External DC Bias is a revolutionary, high performance External Optical Modulator designed for customers developing next generation 40G transmission systems. The 40 Gb/s Intensity Modulator with External DC Bias is based on Titanium-indiffused z-cut Lithium Niobate and uses a Mach-Zehnder interferometric architecture. The 40 Gb/s Intensity Modulator has sufficient bandwidth for customers requiring greater bandwidth to implement today's most demanding FEC schemes.

The 40 Gb/s Intensity Modulator with External DC Bias is ideal for both NRZ and RZ data format solutions. The 40 Gb/s Intensity Modulator with External DC Bias and an Integrated Photodetector is a single-ended drive configuration.

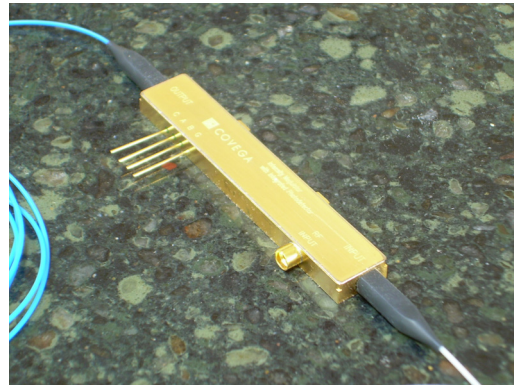

Features

Applications

- ✓ High-Speed Data Communications
 - SONET OC-768 Interfaces
 - SDH STM-256 Interfaces
 - WDM transmission at 40 Gb/s
- ✓ Undersea communications
- ✓ Internet router interfaces
- ✓ High-speed test equipment

- Superior Frequency Performance
- Industry Leading Low Drive Voltage
- Long-Term Bias Stability
- Zero Chirp
- Hermetic Packaging - High Reliability
- C & L Band Operation

Ordering Information

Mach-40 085-40-X-X-X-NS

Part #	Bandwidth	Output Fiber Type	Input Connector	Output Connector	Bias Operating Point
085	40 = 40 GHz*	S = SMF*	S = SC/PC*	S = SC/PC*	NS = Negative Slope
		P = PMF	B = Bare Fiber	B = Bare Fiber	
			F = FC/uPC	F = FC/uPC	
			L = LC/PC	L = LC/PC	
			A = FC/aPC	A = FC/aPC	
			M = Mu	M = Mu	

* Default options unless otherwise specified

Covega Corporation

10335 Guilford Road, Jessup, MD 20794, USA
 Phone: +1 877.226.8342 Fax: +1 240.456.7200 Email: sales@covega.com Web: <http://www.covega.com>

Mach-40™ 085

Specifications

Parameter		Min	Typ	Max	
Operating Case Temperature	T_{CASE}	0		70	C
Operating Wavelength	λ	1525		1605	nm
Optical Insertion Loss (Connectorized)	I.L.		4.0	5.0	dB
Modulator Chirp Parameter	α	-0.7		+0.7	
Optical Return Loss		40			dB
Optical On/Off Extinction Ratio (@ DC)	E.R.	20			dB
Optical Extinction Ratio (PRBS)	E.R.	12.5	13		dB
Bit Rate Frequency	f_{BR}		40		Gb/s
E/O Bandwidth (-3 dB with Linear Fit re. 130 MHz)	f_{C-3dB}	30	35		GHz
S11 (dc to 30 GHz)			-12	-10	dB
S11 (30 to 40 GHz)			-10	-8	dB
RF Drive Voltage (PRBS)	V_{PRBS}		6.5		V
Vpi RF Port (@ 1GHz)	V_{RF}			5.5	V
Vpi Bias Port (@ DC)				10.0	V
DC Bias Voltage Range (EOL)	V_{BIAS}	-8		8	V
PD Responsivity (ref. to output power)		0.1		0.5	mA/mW
Output Optical Power Monitoring Range		-5		10	dBm
Output Monitor Variation		-0.5		0.5	dB
Monitor Photodiode Reverse Bias Voltage		-5.5		-3.0	V
RF Connector	GPPO - Connector				

Packaging

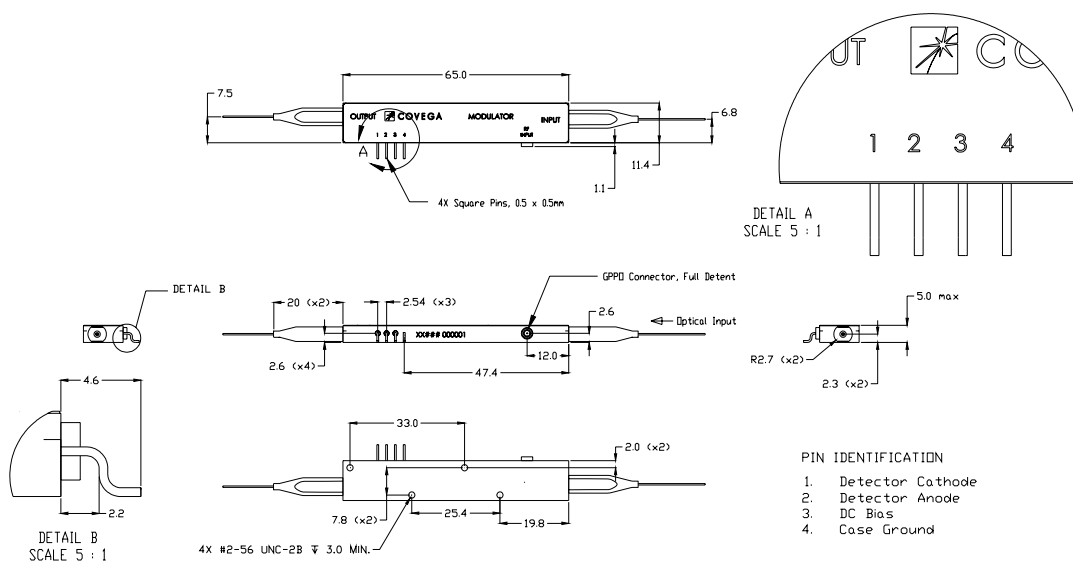

Mach-10™ 060: Dual Parallel Modulator

7.1.2.SP.0060 Rev C

Preliminary Model

Description

COVEGA's Dual-Parallel Modulator is part of the Mach-10™ product line, a family of high performance, Telcordia compliant external optical modulators with industry leading long-term stability. The modulator consists of two Mach Zehnder Interferometers (MZI's) in parallel and is designed for quadrature modulation (QPSK or 4QAM) and single side-band suppressed carrier (SSB-SC) transmission. The Dual-Parallel Modulator is fabricated using titanium-indiffused lithium niobate substrates. Each MZI has an independently controlled bias section to achieve maximum performance.

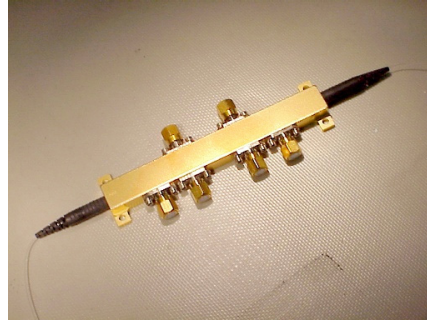

Applications

- ✓ (D) QPSK Transmission for Telecom
- ✓ SSB-SC Transmission for Telecom

Features

- Dual, parallel MZIs on a single x-cut lithium niobate chip
- Separate DC bias for both MZIs
- High Reliability - Long-Term Bias Stability
- Hermetic Packaging

Ordering Information

Mach-10 060-10-X-X-X

Part #	Bandwidth	Output Fiber Type	Input Connector	Output Connector
060	10 = 10 GHz	S = SMF*	S = SC/PC*	S = SC/PC*
		P = PMF	B = Bare Fiber	B = Bare Fiber
			F = FC/uPC	F = FC/uPC
			L = LC/PC	L = LC/PC
			A = FC/aPC	A = FC/aPC
			M = Mu	M = Mu

* Default options unless otherwise specified

Mach-10™ 060

Specifications

Parameter		Min	Typ	Max	
Operating Case Temperature	T_{CASE}	0		70	C
Operating Wavelength	λ	1525		1575	nm
Optical Insertion Loss (Connectorized)	I.L.		5.5	7.0	dB
Insertion Loss Variation (EOL)	$\Delta I.L.$	-0.5		0.5	dB
Optical Return Loss		40			dB
Optical Extinction Ratio (@ DC) per MZI	E.R.	20			dB
V_{π} RF Ports (@ DC)			6.5	7.5	V
V_{π} RF Ports (@ 1GHz)			6.5	7.5	V
V_{π} Bias Ports (@ DC)			4.5	5.5	V
RF Port S11			-12	-10	dB
Bandwidth (-3 dB with Linear Fit)		10			GHz

SPECIFICATIONS SUBJECT TO CHANGE WITHOUT NOTICE

Packaging

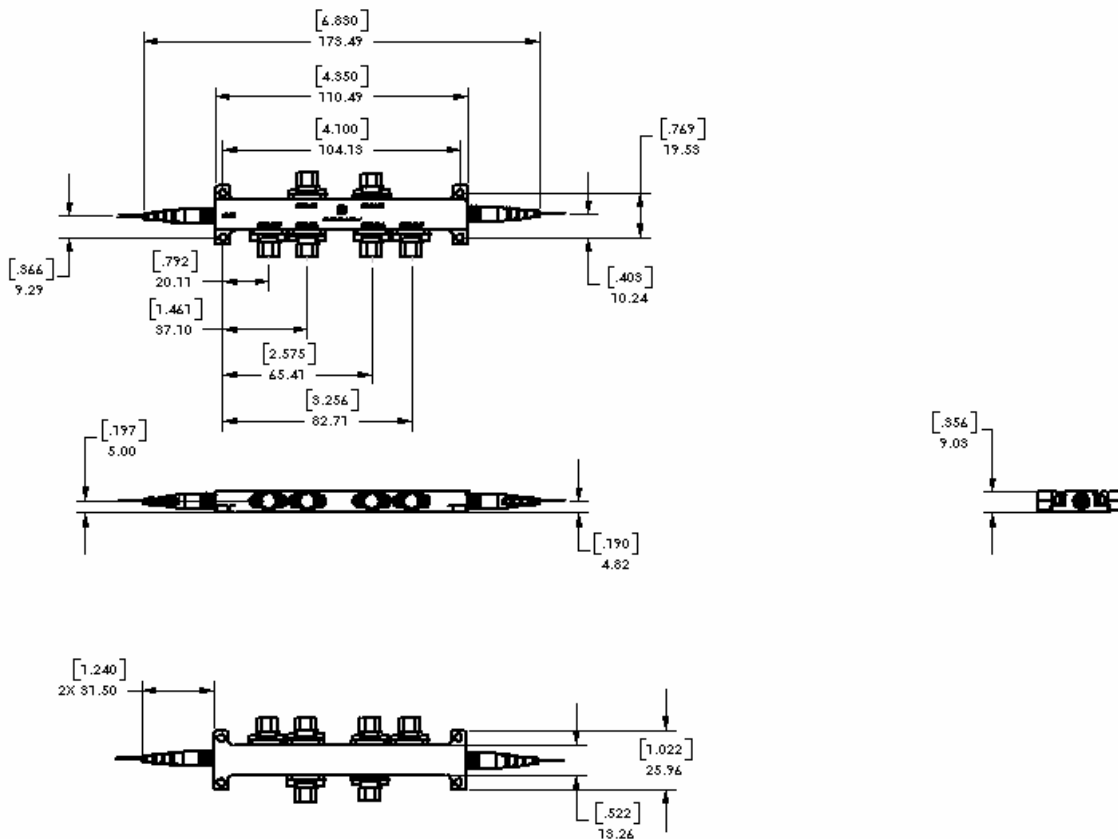

Dimensions in mm unless otherwise specified; Tolerances are ± 0.05 (decimals) ± 1 (angles)

Mach-10™ 081: Zero-Chirp Intensity Modulator with integrated PD using Field Replaceable GPO Connector

7.1.2.SP.0081 Rev A

Description

The Mach-10™ Zero-Chirp Intensity Modulator with Integrated Photodetector was designed for customers seeking small form-factor modulators with increased bandwidth for FEC implementation; supporting data rates from 9.953 Gb/s to 12.5 Gb/s. The Zero-Chirp Intensity Modulator with Integrated Photodetector is based on Titanium-indiffused x-cut Lithium Niobate and uses a Mach-Zehnder interferometric architecture. Designed for integration into 300 pin MSA compatible transponders, it is ideal for metro and long-haul DWDM applications requiring less than a 2 dB power penalty for +/-1,200 ps/nm dispersion.

The integrated photodetector can be used for optical power monitoring and modulator bias control, eliminating the need for an external fiber tap and splicing. The extremely small footprint and low profile make it ideal for customers seeking to reduce the size of their current 300 pin MSA compatible metro or long-haul transponder platforms. The Zero-Chirp Intensity Modulator with Integrated Photodetector is a single-ended drive configuration.

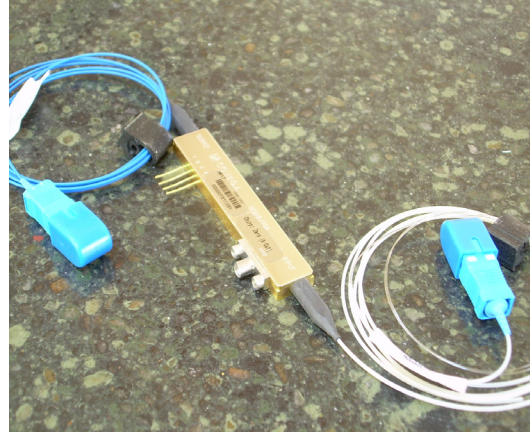

Applications

- ✓ High-Speed Data Communications
 - SONET OC-192 Interfaces
 - SDH STM-64 Interfaces
 - WDM transmission at +10 Gb/s
- ✓ Undersea Communications
- ✓ Internet Router Interfaces
- ✓ High-speed test equipment

Features

- Superior Frequency Performance
- Small Size – 300 pin MSA Transponder Compatible Footprint with FR SMP connector
- Low Drive Voltage
- Long-Term Bias Stability
- Hermetic Packaging - High Reliability - Telcordia GR-468 Compliant
- Integrated Photodetector
- C & L Band Operation

Ordering Information

Mach-10 081-XX-X-X-X-XX						
Part #	Bandwidth	Output Fiber Type	Input Connector	Output Connector	Bias Operating Point	Pin Leads
081	10 = 10 GHz*	S = SMF*	S = SC/PC*	S = SC/PC*	PS = Pos. Slope	BNL = Bent*
	12 = 12 GHz	P = PMF	B = Bare Fiber	B = Bare Fiber	NS = Neg. Slope*	STL = Straight
			F = FC/uPC	F = FC/uPC	PK = Peak	
			L = LC/PC	L = LC/PC	NL = Null	
			A = FC/aPC	A = FC/aPC		
			M = Mu	M = Mu		
* Default options unless otherwise specified						

Mach-10™ 081

Specifications

Parameter		Min	Typ	Max	
Operating Case Temperature	T_{CASE}	0		70	C
Operating Wavelength	λ	1525		1605	nm
Optical Insertion Loss (Connectorized)	I.L.		4.0	5.0	dB
Insertion Loss Variation (EOL)	$\Delta I.L.$	-0.5		0.5	dB
Modulator Chirp Parameter	α	-0.1		0.1	
Optical Return Loss		40			dB
Optical On/Off Extinction Ratio (@ DC)	E.R.	20			dB
Optical Extinction Ratio (PRBS)	E.R.	13			dB
Bit Rate Frequency	f_{BR}	9.953		12.5	Gb/s
E/O Bandwidth (-3 dB with Linear Fit)	f_{C-3dB}	10.0	12.0		GHz
S11 (dc to 10 GHz)			-12	-10	dB
RF Drive Voltage (PRBS)	V_{PRBS}		5.5	6	V
Vpi Bias Port (@ DC)				8	V
DC Bias Voltage Range (EOL)	V_{BIAS}	-8		8	V
PD Responsivity (ref. to output power)		0.1		0.5	mA/mW
Output Optical Power Monitoring Range		-5		10	dBm
Output Monitor Variation		-0.5		0.5	dB
Monitor Photodiode Reverse Bias Voltage		-5.5		-3.0	V

SPECIFICATIONS SUBJECT TO CHANGE WITHOUT NOTICE

Packaging

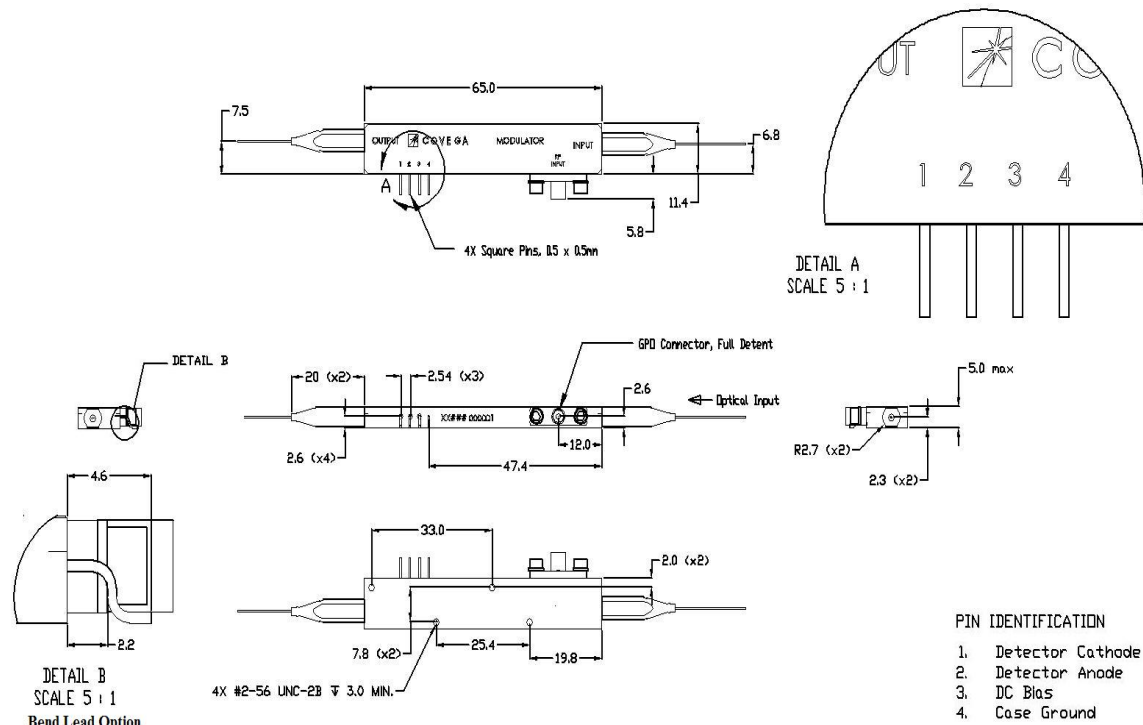

Dimensions in mm unless otherwise specified; Tolerances are ± 0.05 (decimals) ± 1 (angles)

Mach-10™ 082: Fixed-Chirp Intensity Modulator with integrated PD using Field Replaceable GPO Connector

7.1.2.SP.0082 Rev A

Description

The Mach-10™ Zero-Chirp Intensity Modulator with Integrated Photodetector was designed for customers seeking small form-factor modulators with increased bandwidth for FEC implementation; supporting data rates from 9.953 Gb/s to 12.5 Gb/s. The Zero-Chirp Intensity Modulator with Integrated Photodetector is based on Titanium-indiffused x-cut Lithium Niobate and uses a Mach-Zehnder interferometric architecture. Designed for integration into 300 pin MSA compatible transponders, it is ideal for metro and long-haul DWDM applications requiring less than a 2 dB power penalty for +/-1,200 ps/nm dispersion.

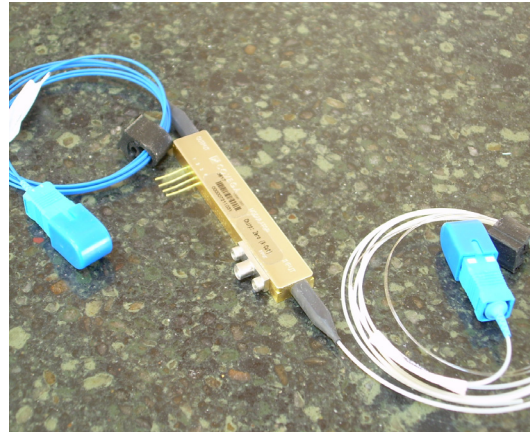

The integrated photodetector can be used for optical power monitoring and modulator bias control, eliminating the need for an external fiber tap and splicing. The extremely small footprint and low profile make it ideal for customers seeking to reduce the size of their current 300 pin MSA compatible metro or long-haul transponder platforms. The Zero-Chirp Intensity Modulator with Integrated Photodetector is a single-ended drive configuration.

Applications

- ✓ High-Speed Data Communications
 - SONET OC-192 Interfaces
 - SDH STM-64 Interfaces
 - WDM transmission at +10 Gb/s
- ✓ Undersea Communications
- ✓ Internet Router Interfaces
- ✓ High-speed test equipment

Features

- Superior Frequency Performance
- Small Size – 300 pin MSA Transponder Compatible Footprint with FR SMP connector
- Low Drive Voltage
- Long-Term Bias Stability
- Hermetic Packaging - High Reliability - Telcordia GR-468 Compliant
- Integrated Photodetector
- C & L Band Operation

Ordering Information

Mach-10 082-XX-X-X-X-XX						
Part #	Bandwidth	Output Fiber Type	Input Connector	Output Connector	Bias Operating Point	Pin Leads
082	10 = 10 GHz*	S = SMF*	S = SC/PC*	S = SC/PC*	PS = Pos. Slope	BNL = Bent*
	12 = 12 GHz	P = PMF	B = Bare Fiber	B = Bare Fiber	NS = Neg. Slope*	STL = Straight
			F = FC/uPC	F = FC/uPC	PK = Peak	
			L = LC/PC	L = LC/PC	NL = Null	
			A = FC/aPC	A = FC/aPC		
			M = Mu	M = Mu		
* Default options unless otherwise specified						

Mach-10™ 082

Specifications

Parameter		Min	Typ	Max	
Operating Case Temperature	T_{CASE}	0		70	C
Operating Wavelength	λ	1525		1605	nm
Optical Insertion Loss (Connectorized)	I.L.		4.0	5.0	dB
Insertion Loss Variation (EOL)	$\Delta I.L.$	-0.5		0.5	dB
Modulator Chirp Parameter	α	0.6		0.8	
Optical Return Loss		40			dB
Optical On/Off Extinction Ratio (@ DC)	E.R.	20			dB
Optical Extinction Ratio (PRBS)	E.R.	13			dB
Bit Rate Frequency	f_{BR}	9.953		12.5	Gb/s
E/O Bandwidth (-3 dB with Linear Fit)	f_{C-3dB}	10.0	12.0		GHz
S11 (dc to 10 GHz)			-12	-10	dB
RF Drive Voltage (PRBS)	V_{PRBS}		5.5	6	V
Vpi Bias Port (@ DC)				8	V
DC Bias Voltage Range (EOL)	V_{BIAS}	-8		8	V
PD Responsivity (ref. to output power)		0.1		0.5	mA/mW
Output Optical Power Monitoring Range		-5		10	dBm
Output Monitor Variation		-0.5		0.5	dB
Monitor Photodiode Reverse Bias Voltage		-5.5		-3.0	V

SPECIFICATIONS SUBJECT TO CHANGE WITHOUT NOTICE

Packaging

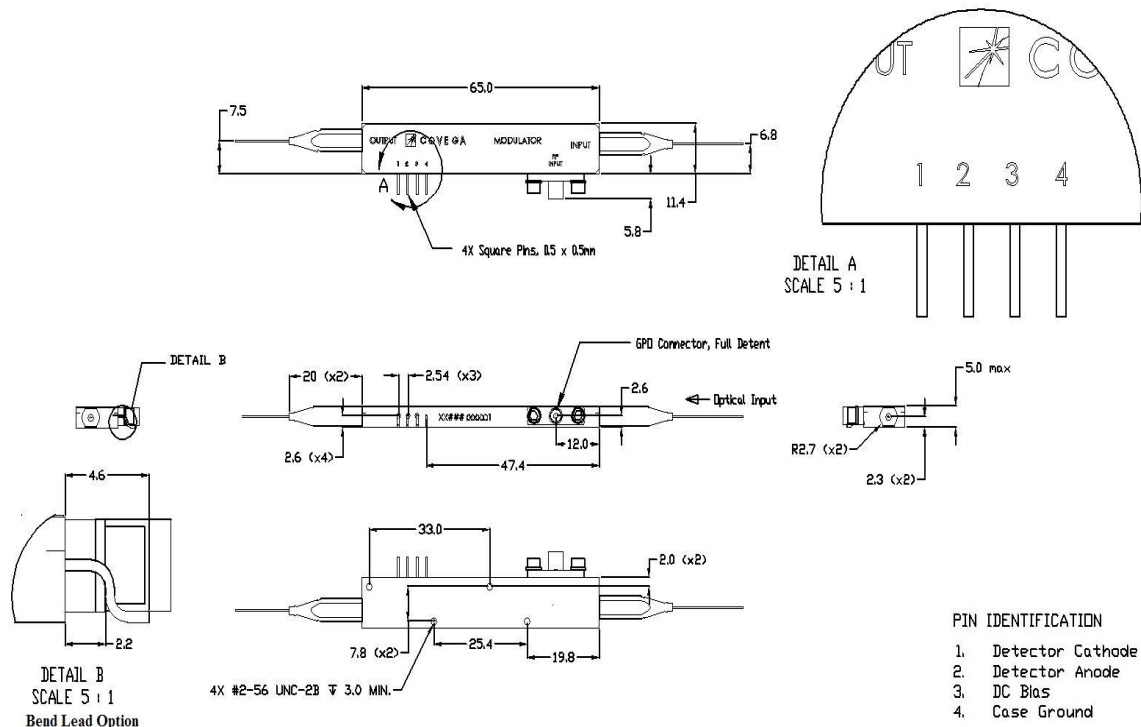

Dimensions in mm unless otherwise specified; Tolerances are ± 0.05 (decimals) ± 1 (angles)



Covega Corporation
10335 Guilford Road, Jessup, MD 20794, USA
Phone: +1 877.226.8342 **Fax:** +1 240.456.7200
Email: sales@covega.com **Web:** <http://www.covega.com>



Covega Corporation
10335 Guilford Road, Jessup, MD 20794, USA
Phone: +1 877.226.8342 **Fax:** +1 240.456.7200
Email: sales@covega.com **Web:** <http://www.covega.com>

Indium Phosphide Products

BOA 1004: C-band Booster Optical Amplifier

7.1.2.SP.1004 Rev C

Description

The BOA 1004 is a high saturation output power high bandwidth polarization maintaining Booster Optical Amplifier (BOA). It incorporates a highly efficient InP/InGaAsP Quantum Well (QW) layer structure and a reliable ridge waveguide design.

It is housed in a standard 14 pin butterfly package with integrated thermoelectric cooler and thermistor. Packaging options include isolator(s) and choice of single mode fiber and polarization maintaining fiber tails.

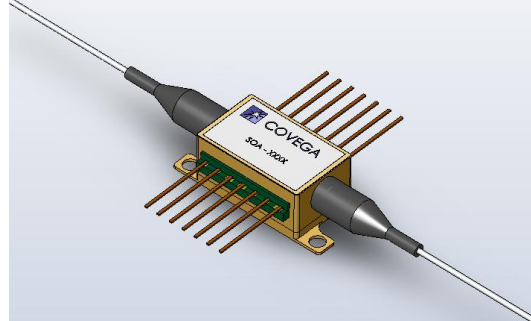

Features

- High Saturation Output Power
- Broad Spectral Bandwidth
- High Fiber-to-Fiber Gain
- High Polarization Extinction Ratio

Applications

- ✓ Telecom & Datacom
- ✓ Booster Amplifier of Fixed and Tunable ITU Lasers and Transmitters
- ✓ Research & Non-Linear Applications

Specifications

CW; T (Chip) = 25°C, T (Case) = 0 - 70°C

Parameter		Min	Typ	Max	
Operating Current	I_{OP}		500	600	mA
Central Wavelength	λ_C	1530	1550	1570	nm
ASE Optical 3 dB Bandwidth	BW	80	85		nm
Saturation Output Power @ -3 dB	P_{SAT}	13	15		dBm
Small Signal Gain across BW @ Pin = -20 dBm	G	20	24		dB
Gain Ripple (p-p) @ I_{OP}	δG		0.05	0.2	dB
Polarization Extinction Ratio	PER		18		dB
Noise Figure	NF		7.5	9	dB
Forward Voltage	V_F		1.3	1.6	V
TEC Operation (typ / max @ $T_{CASE} = 25^\circ C / 70^\circ C$)					
- TEC Current	I_{TEC}		0.13	1.5	A
- TEC Voltage	V_{TEC}		0.28	3.5	V
- Thermistor Resistance	R_{TH}		10K		Ω

SPECIFICATIONS ARE SUBJECT TO CHANGE WITHOUT NOTICE

The picture is a representation. The actual part may vary from the one shown.

BOA 1004

Performance

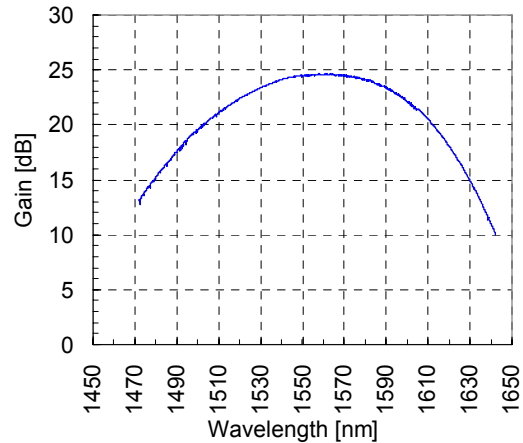
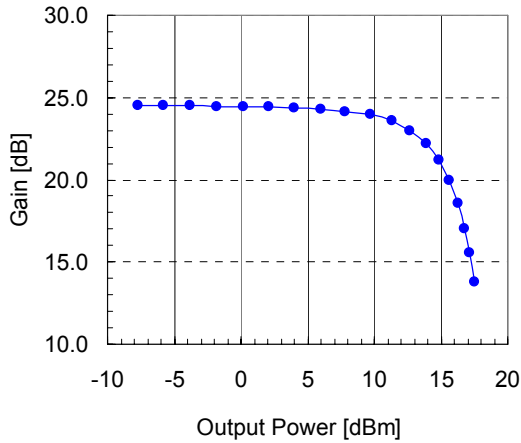

Packaging

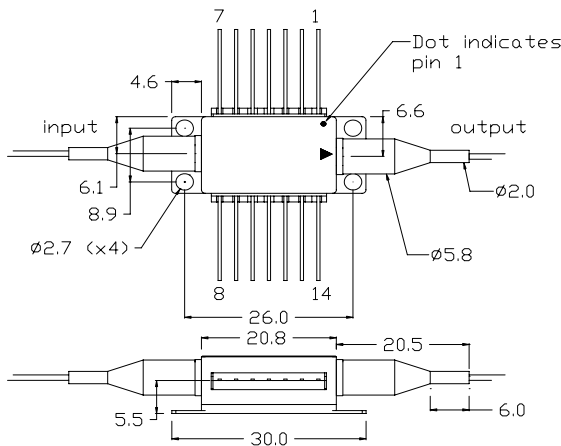

PIN IDENTIFICATION

- | | |
|---------------|-----------------|
| 1. TEC + | 14. TEC - |
| 2. Thermistor | 13. Case |
| 3. NC | 12. NC |
| 4. NC | 11. SDA Cathode |
| 5. Thermistor | 10. SDA Anode |
| 6. NC | 9. NC |
| 7. NC | 8. NC |

Recommended mounting torque is 10-20oz.in (0.07-0.14N.m).

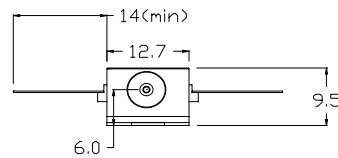

all dimensions in mm

Ordering Information

BOA 1004 - X - 0 - X - X - X - X - X							
X	0	X	X	X	X	X	Numeric
Isolator	Reserved	Fiber jacket configuration*	Input Fiber	Output Fiber	Input Connector	Output Connector	Reserved
0 = none		U = SMF-28, loose tube	S = SMF	S = SMF	B = Bare Fiber	B = Bare Fiber	
1 = input only		T = SMF-28, tight jacket	P = PMF	P = PMF	A = FC/APC	A = FC/APC	1 = Reserved
2 = output only		V = PMF 1550 nm, loose tube			O = Other	O = Other	2 = Reserved
3 = input & output							

* see separate fibertail options datasheet

© Covega Corporation - All rights reserved

BOA 1007: C-band Booster Optical Amplifier Chip

7.1.2.SP.1007 Rev C

Description

The BOA 1007 is a high saturation output power high bandwidth polarization maintaining Booster Optical Amplifier (BOA). It incorporates a highly efficient InP/InGaAsP Quantum Well (QW) layer structure and a reliable ridge waveguide design.

Packaging options include, bare die, chip on submount and various general and custom heat sinks

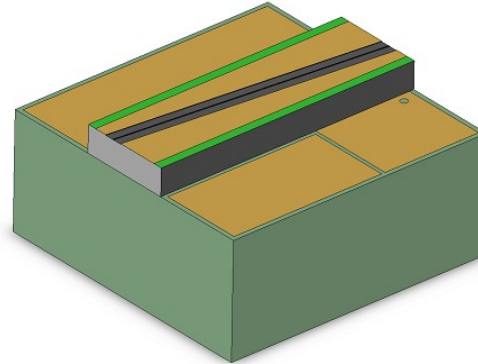

Features

Applications

- ✓ Telecom & Datacom
- ✓ Booster Amplifier of Fixed and Tunable ITU Lasers and Transmitters
- ✓ Research
- ✓ Non-Linear Applications

- High Saturation Output Power
- Broad Spectral Bandwidth
- High Gain
- High Polarization Extinction Ratio

Specifications

CW, T (Chip) = 25°C

Parameter		Min	Typ	Max	
Operating Current	I_{OP}		500		mA
Central Wavelength	λ_C	1530	1550	1570	nm
Optical 3 dB Bandwidth	BW	80	85		nm
Saturation Output Power @ -3 dB	P_{SAT}	15	18		dBm
Small Signal Gain across BW @ Pin = -20 dBm	G	23	28		dB
Gain Ripple (p-p) @ I_{OP}	δG		0.05	0.2	dB
Polarization Extinction Ratio	PER		18		dB
Chip Noise Figure	NF		6	8	dB
Forward Voltage	V_F		1.3	1.6	V
Chip Length	L		1.5		mm
Lateral Beam Exit Angle	θ_{EXT}		19.5		deg
Beam Divergence Angle (FWHM)					
- Transverse	θ_T	32	36	40	deg
- Lateral	θ_L	10	14	18	deg

SPECIFICATIONS ARE SUBJECT TO CHANGE WITHOUT NOTICE

The picture is a representation. The actual part may vary from the one shown.

BOA 1007

Performance

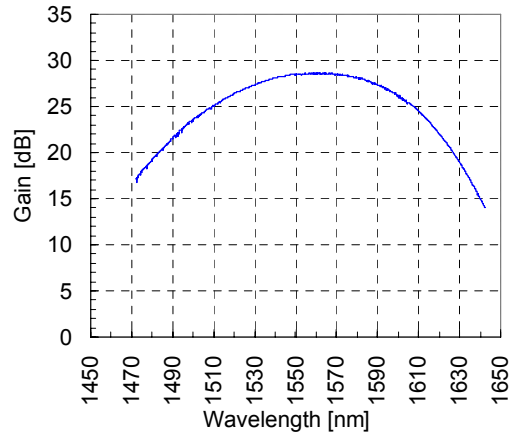
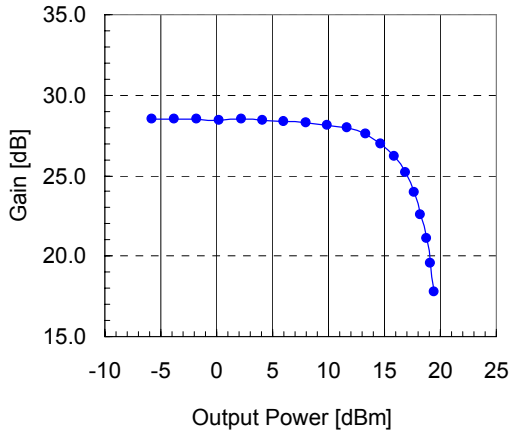

Packaging

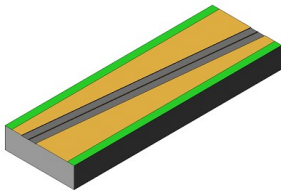

Bare Die

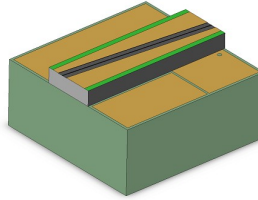

Chip on Submount

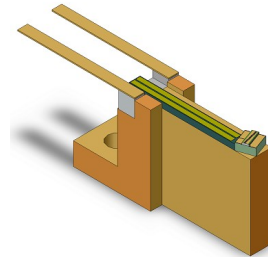

Chip on Heatsink

Ordering Information

BOA 1007 - XXX

XXX

Submount

DIE = Bare Die

COS = Chip on Submount

HTS = Heatsink

ZZZ = Custom Mount

© Covega Corporation - All rights reserved

BOA 1017: O-band Booster Optical Amplifier

7.1.2.SP.1017 Rev C

Description

The BOA 1017 is a high saturation output power high bandwidth polarization maintaining Booster Optical Amplifier (BOA). It incorporates a highly efficient InP/InGaAsP Quantum Well (QW) layer structure and a reliable ridge waveguide design.

It is housed in a standard 14 pin butterfly package with integrated thermoelectric cooler and thermistor. Packaging options include isolator(s) and choice of single mode fiber and polarization maintaining fiber tails.

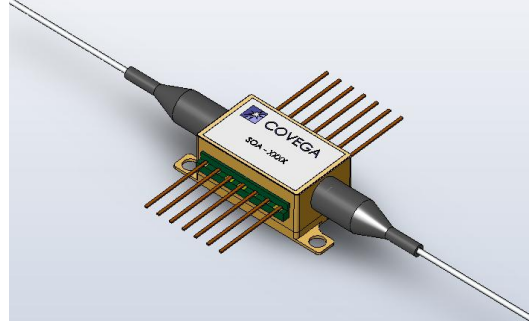

Features

- High Saturation Output Power
- Broad Spectral Bandwidth
- High Fiber-to-Fiber Gain
- High Polarization Extinction Ratio

Applications

- ✓ Telecom & Datacom
- ✓ Booster Amplifier of Fixed and Tunable ITU Lasers and Transmitters
- ✓ Research & Non-Linear Applications

Specifications

CW; T (Chip) = 25°C, T (Case) = 0 - 70°C

Parameter		Min	Typ	Max	
Operating Current	I_{OP}		500	600	mA
Central Wavelength	λ_C	1290	1310	1330	nm
Optical 3 dB Bandwidth	BW	60	70		nm
Saturation Output Power @ -3 dB	P_{SAT}	13	15		dBm
Small Signal Gain across BW @ Pin = -20 dBm	G	17	23		dB
Gain Ripple (p-p) @ I_{OP}	δG		0.3	0.8	dB
Polarization Extinction Ratio	PER		16		dB
Noise Figure	NF		7.0	9.0	dB
Forward Voltage	V_F		1.4	1.6	V
TEC Operation (typ / max @ $T_{CASE} = 25^\circ C / 70^\circ C$)					
- TEC Current	I_{TEC}		0.15	1.5	A
- TEC Voltage	V_{TEC}		0.35	3.5	V
- Thermistor Resistance	R_{TH}		10K		Ω

SPECIFICATIONS ARE SUBJECT TO CHANGE WITHOUT NOTICE

The picture is a representation. The actual part may vary from the one shown.

BOA 1017

Performance

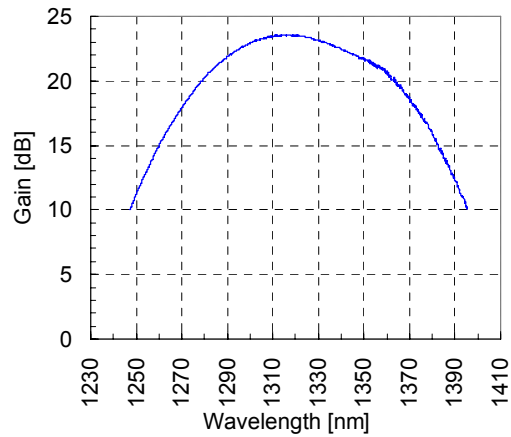
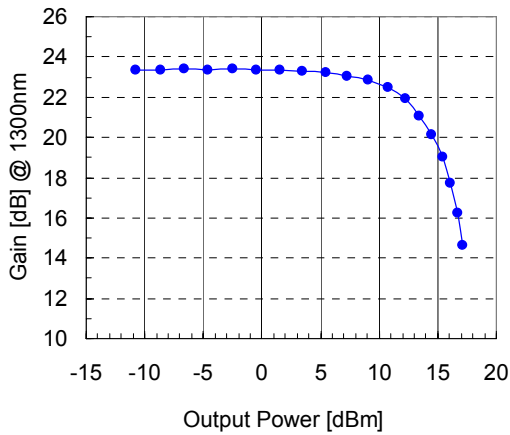

Packaging

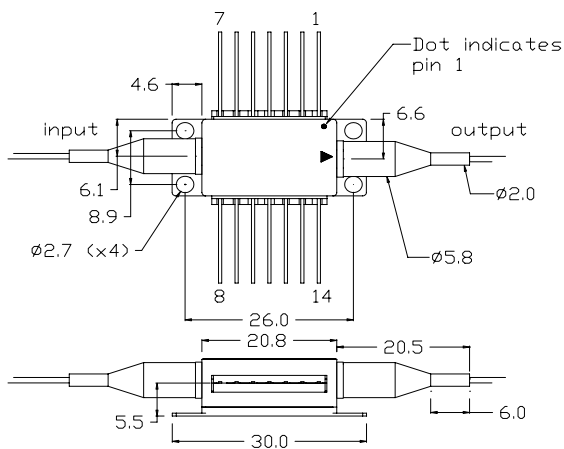

PIN IDENTIFICATION

- | | |
|---------------|-----------------|
| 1. TEC + | 14. TEC - |
| 2. Thermistor | 13. Case |
| 3. NC | 12. NC |
| 4. NC | 11. SDA Cathode |
| 5. Thermistor | 10. SDA Anode |
| 6. NC | 9. NC |
| 7. NC | 8. NC |

Recommended mounting torque is 10-20oz.in (0.07-0.14N.m).

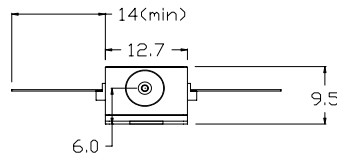

all dimensions in mm

Ordering Information

BOA 1017 - X - 0 - X - X - X - X - X

X	0	X	X	X	X	X	Numeric
Isolator	Reserved	Fiber jacket configuration*	Input Fiber	Output Fiber	Input Connector	Output Connector	Reserved
0 = none		U = SMF-8, loose tube	S = SMF	S = SMF	A = FC/APC	A = FC/APC	
1 = input only		T = SMF-28, tight jacket	P = PMF	P = PMF			
2 = output only		W = PMF 1300 nm, loose tube					
3 = input & output							

* See fibertail options details in catalog

© Covega Corporation - All rights reserved

BOA 1080: L-band Booster Optical Amplifier

7.1.2.SP.1080 Rev B

Engineering Models / Limited Warranty

Description

The BOA 1080 is a high saturation output power high bandwidth polarization maintaining Booster Optical Amplifier (BOA). It incorporates a highly efficient InP/InGaAsP Quantum Well (QW) layer structure and a reliable ridge waveguide design.

It is housed in a standard 14 pin butterfly package with integrated thermoelectric cooler and thermistor. Packaging options include isolator(s) and choice of single mode fiber and polarization maintaining fiber tails.

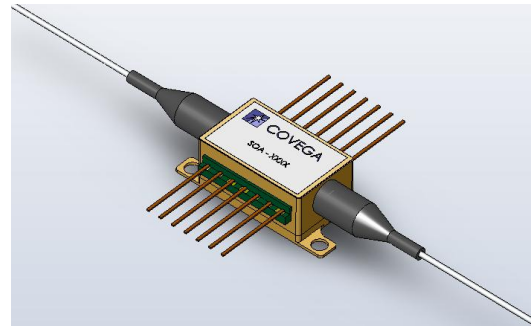

Features

Applications

- ✓ Telecom & Datacom
- ✓ Chemical Sensing
- ✓ Research & Non-Linear Applications

- High Saturation Output Power
- Broad Spectral Bandwidth
- High Fiber-to-Fiber Gain
- High Polarization Extinction Ratio

Specifications

CW; T (Chip) = 25°C, T (Case) = 0 - 70°C

Parameter		Min	Typ	Max	
Operating Current	I_{OP}		500	600	mA
Central Wavelength	λ_C	1570	1590	1610	nm
Optical 3 dB Bandwidth	BW	80	90		nm
Saturation Output Power @ -3 dB	P_{SAT}	12	15		dBm
Small Signal Gain across BW @ Pin = -20 dBm	G	17	25		dB
Gain Ripple (p-p) @ I_{OP}	δG		0.05	0.2	dB
Polarization Extinction Ratio	PER		TBD		dB
Noise Figure	NF		8	10	dB
Forward Voltage	V_F		1.5	2.0	V
TEC Operation (typ / max @ $T_{CASE} = 25^\circ C / 70^\circ C$)					
- TEC Current	I_{TEC}		0.12	1.5	A
- TEC Voltage	V_{TEC}		0.25	4	V
- Thermistor Resistance	R_{TH}		10K		Ω

SPECIFICATIONS SUBJECT TO CHANGE WITHOUT NOTICE

The picture is a representation. The actual part may vary from the one shown.

* This device is still under development. Check with Sales for availability.

BOA 1080

Performance

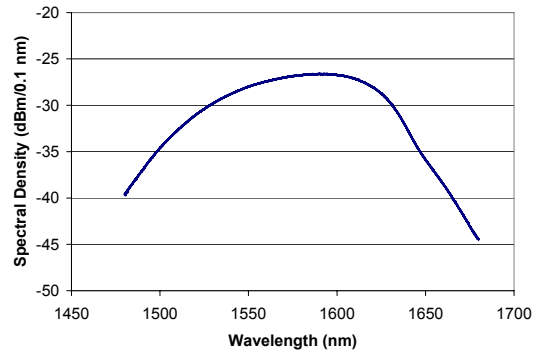
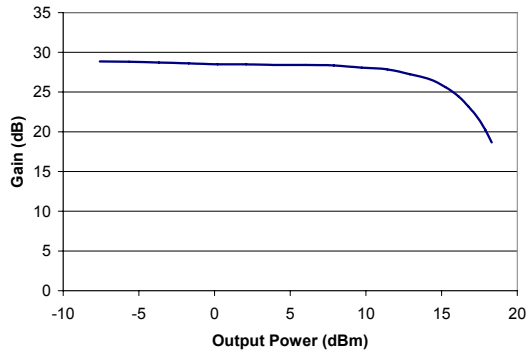

Packaging

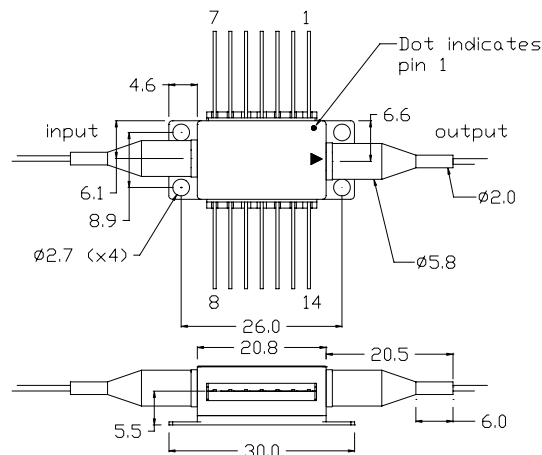

PIN IDENTIFICATION

- | | |
|---------------|-----------------|
| 1. TEC + | 14. TEC - |
| 2. Thermistor | 13. Case |
| 3. NC | 12. NC |
| 4. NC | 11. SDA Cathode |
| 5. Thermistor | 10. SDA Anode |
| 6. NC | 9. NC |
| 7. NC | 8. NC |

Recommended mounting torque is 10-20oz.in (0.07-0.14N.m).

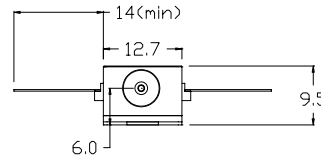

all dimensions in mm

Ordering Information

BOA 1080 - X - 0 - X - X - X - X - X

X	0	X	X	X	X	X	Numeric
Isolator	Reserved	Fiber jacket configuration*	Input Fiber	Output Fiber	Input Connector	Output Connector	Reserved
0 = none		U = SMF-28, loose tube	S = SMF	S = SMF	A = FC/APC	A = FC/APC	0
		T = SMF-28, tight jacket	P = PMF	P = PMF			
		V = PMF 1550 nm, loose tube					

Custom orders with isolators require a minimum purchase quantity.

* see separate fibertail options in catalogue

© Covega Corporation - All rights reserved

The picture is a representation. The actual part may vary from the one shown.

BOA 1082: Super L-band Booster Optical Amplifier

7.1.2.SP.1082 Rev B

Engineering*

Description

The BOA 1082 is a high saturation output power high bandwidth polarization maintaining Booster Optical Amplifier (BOA). It incorporates a highly efficient InP/InGaAsP Quantum Well (QW) layer structure and a reliable ridge waveguide design.

It is housed in a standard 14 pin butterfly package with integrated thermoelectric cooler and thermistor. Packaging options include isolator(s) and choice of single mode fiber and polarization maintaining fiber tails.

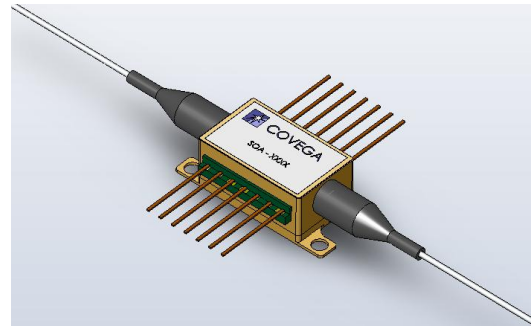

Features

Applications

- ✓ Telecom & Datacom
- ✓ Chemical Sensing
- ✓ Research & Non-Linear Applications

- High Saturation Output Power
- Broad Spectral Bandwidth
- High Fiber-to-Fiber Gain
- High Polarization Extinction Ratio

Specifications

CW; T (Chip) = 25°C, T (Case) = 0 - 70°C

Parameter		Min	Typ	Max	
Operating Current	I_{OP}		600		mA
Central Wavelength	λ_C	1600	1625	1650	nm
Optical 3 dB Bandwidth	BW	60	80		nm
Saturation Output Power @ -3 dB	P_{SAT}	10	13		dBm
Small Signal Gain across BW @ Pin = -20 dBm	G	14	18		dB
Gain Ripple (RMS) @ I_{OP}	δG		0.05	0.3	dB
Polarization Extinction Ratio	PER		TBD		dB
Noise Figure	NF		8	12	dB
Forward Voltage	V_F		1.5	2.0	V
TEC Operation (typ / max @ $T_{CASE} = 25^\circ C / 70^\circ C$)					
- TEC Current	I_{TEC}		0.12	1.5	A
- TEC Voltage	V_{TEC}		0.25	4	V
- Thermistor Resistance	R_{TH}		10K		Ω

SPECIFICATIONS SUBJECTED TO CHANGE WITHOUT NOTICE

The picture is a representation. The actual part may vary from the one shown.

* This device is still under development. Check with Sales for availability.

BOA 1082

Packaging

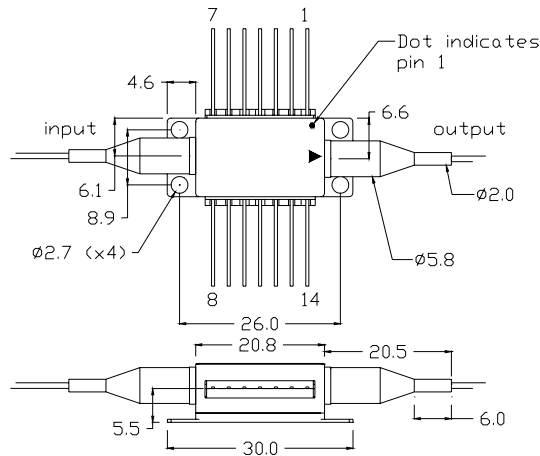

PIN IDENTIFICATION

- | | |
|---------------|-----------------|
| 1. TEC + | 14. TEC - |
| 2. Thermistor | 13. Case |
| 3. NC | 12. NC |
| 4. NC | 11. SDA Cathode |
| 5. Thermistor | 10. SDA Anode |
| 6. NC | 9. NC |
| 7. NC | 8. NC |

Recommended mounting torque is 10-20oz.in (0.07-0.14N.m).

all dimensions in mm

Ordering Information

BOA 1082 - X - 0 - X - X - X - X - X							
X	0	X	X	X	X	X	Numeric
Isolator	Reserved	Fiber jacket configuration*	Input Fiber	Output Fiber	Input Connector	Output Connector	Reserved
0 = none		U = SMF-28, loose tube	S = SMF	S = SMF	A = FC/APC	A = FC/APC	0
		T = SMF-28, tight jacket	P = PMF	P = PMF			
		V = PMF 1550 nm, loose tube					

Isolators require a minimum purchase quantity.
 * see separate fibertail options datasheet in catalog

© Covega Corporation - All rights reserved

The picture is a representation. The actual part may vary from the one shown.

SOA 1013: 1550nm C-band Semiconductor Optical Amplifier

7.1.2.SP.1013 Rev E

Description

COVEGA's 1013 SOA is a polarization insensitive optical amplifier housed in a standard 14-pin butterfly package. Advanced epitaxial wafer growth and opto-electronic packaging techniques enable high output saturation power, low noise figure, and large gain across a broad spectral bandwidth.

Packaging options include input and output optical isolators, SMF and PMF fiber tails and choice of connectors.

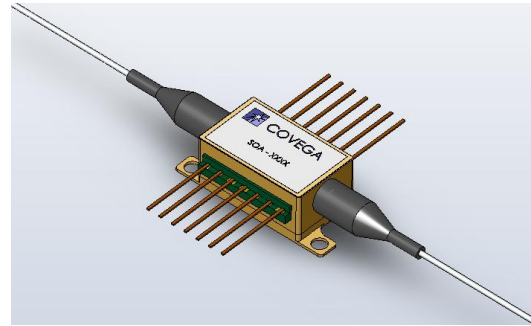

Features

Applications

- ✓ Optical Booster and In-line Amplification in WDM Metro Network Systems
 - ✓ Optical Loss Compensator
 - Channel Launch (Modulator)
 - Mid-Stage (Add/Drop)
 - ✓ Pre-Amplifier
 - ✓ High Speed optical on/off switch
- High Fiber-to-Fiber Gain
 - Broad Spectral Bandwidth
 - High Fiber-to-Fiber Gain

Specifications

CW; T (Chip) = 25°C, T (Case) = 0 - 70°C

Parameter		Min	Typ	Max	
Operating Current	I_{OP}		500	600	mA
Operating Wavelength Range: C-band	Λ	1528		1562	nm
Peak Wavelength	λ_C	1480	1500	1520	nm
Optical 3 dB Bandwidth	BW	70	74		nm
Saturation Output Power @ -3 dB	P_{SAT}	12	14		dBm
Small Signal Gain over C-band Λ @ $P_{in} = -20$ dBm	G	10	13		dB
Gain Flatness over C-band Λ @ $P_{in} = -20$ dBm	ΔG		5	7	dB
Gain Ripple (p-p) @ I_{OP}, λ_C	δG		0.1	0.5	dB
Polarization Dependent Gain	PDG		1.0	1.5	dB
Noise Figure	NF		8	9.5	dB
Forward Voltage	V_F		1.6	1.8	V
TEC Operation (typ / max @ $T_{CASE} = 25^\circ C / 70^\circ C$)					
- TEC Current	I_{TEC}		0.23	1.5	A
- TEC Voltage	V_{TEC}		0.5	3.5	V
- Thermistor Resistance	R_{TH}		10K		Ω

SPECIFICATIONS ARE SUBJECT TO CHANGE WITHOUT NOTICE

The picture is a representation. The actual part may vary from the one shown.

SOA 1013

Performance

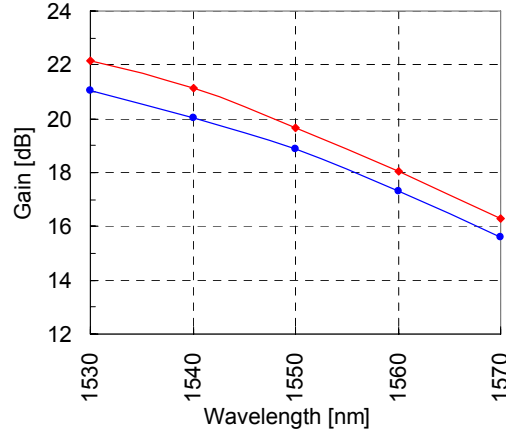
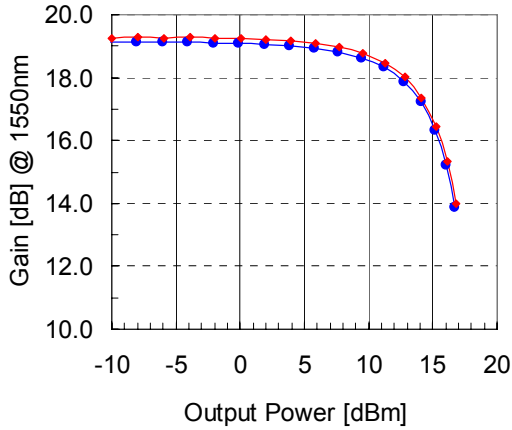

Packaging

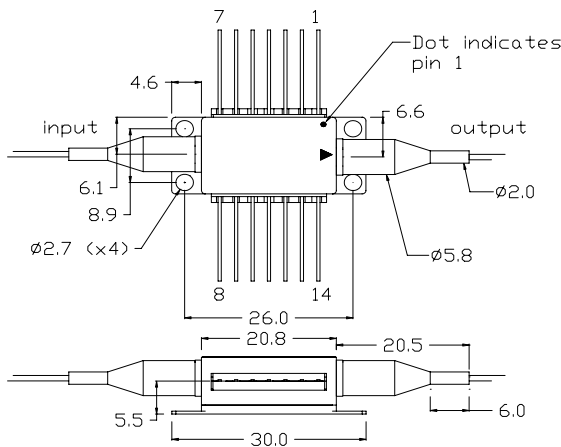

PIN IDENTIFICATION

- | | |
|---------------|-----------------|
| 1. TEC + | 14. TEC - |
| 2. Thermistor | 13. Case |
| 3. NC | 12. NC |
| 4. NC | 11. SDA Cathode |
| 5. Thermistor | 10. SDA Anode |
| 6. NC | 9. NC |
| 7. NC | 8. NC |

Recommended mounting torque is 10-20oz.in (0.07-0.14N.m).

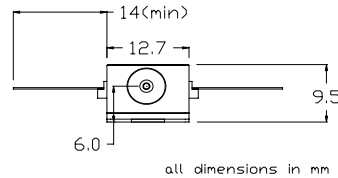

Ordering Information

SOA 1013 - X - 0 - X - X - X - X - X							
X	0	X	X	X	X	X	Numeric
Isolator	Reserved	Fiber jacket configuration*	Input Fiber	Output Fiber	Input Connector	Output Connector	Reserved
0 = none		U = SMF-8, loose tube	S = SMF	S = SMF	A = FC/APC	A = FC/APC	
1 = input only		T = SMF-28, tight jacket	P = PMF#	P = PMF#			
2 = output only		V = PMF 1550 nm, loose tube#					
3 = input & output							

Isolators are available only on SM fiber configurations
 * see separate fibertail options datasheet

© Covega Corporation - All rights reserved

The picture is a representation. The actual part may vary from the one shown.

SOA 1117: 1550nm Semiconductor Optical Amplifier, Non-Linear

7.1.2.SP.1117 Rev F

Description

COVEGA's 1117 SOA is a polarization insensitive optical amplifier housed in a standard 14-pin butterfly package. Advanced epitaxial wafer growth and opto-electronic packaging techniques enable high output saturation power, low noise figure, and large gain across a broad spectral bandwidth.

Packaging options include input and output isolators, SMF and PMF fiber tails and choice of connectors.

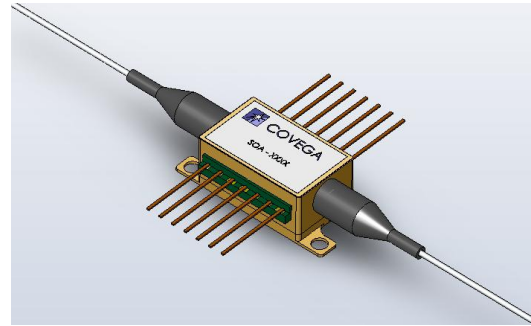

Features

Applications

- ✓ Optical Booster and In-line Amplification in WDM Metro Network Systems
- ✓ Optical Loss Compensator
 - Channel Launch (Modulator)
 - Mid-Stage (Add/Drop)
- ✓ Pre-Amplifier
- ✓ Non-Linear Applications such as 2R / 3R Regeneration, Four Wave Mixing, Wavelength Conversion

- High Fiber-to-Fiber Gain
- Broad Spectral Bandwidth
- Optimized for Non-Linear Applications

Specifications

CW; T (Chip) = 25°C, T (Case) = 0 - 70°C

Parameter		Min	Typ	Max	
Operating Current	I_{OP}		500	600	mA
Operating Wavelength Range: C-band	Λ	1528		1562	nm
Central Wavelength	λ_C	1520	1550	1570	nm
Optical 3 dB Bandwidth	BW	50	60		nm
Saturation Output Power @ -3 dB across Λ	P_{SAT}	6	9		dBm
Small Signal Gain across Λ @ $P_{in} = -20$ dBm	G	15	20		dB
Gain Ripple (p-p) @ I_{OP}	δG		0.2	0.5	dB
Polarization Dependent Gain	PDG		1	2.5	dB
Noise Figure	NF		9	11	dB
Forward Voltage	V_F		1.4	2.0	V
TEC Operation (typ / max @ $T_{CASE} = 25^\circ C / 70^\circ C$)					
- TEC Current	I_{TEC}		0.2	1.2	A
- TEC Voltage	V_{TEC}		0.4	3.5	V
- Thermistor Resistance	R_{TH}		10K		Ω

SPECIFICATIONS SUBJECT TO CHANGE WITHOUT NOTICE

The picture is a representation. The actual part may vary from the one shown.

SOA 1117

Performance

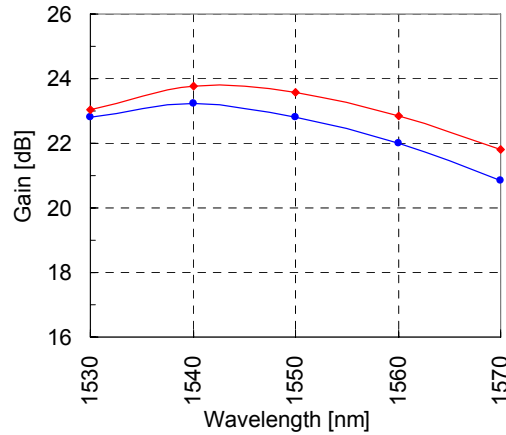
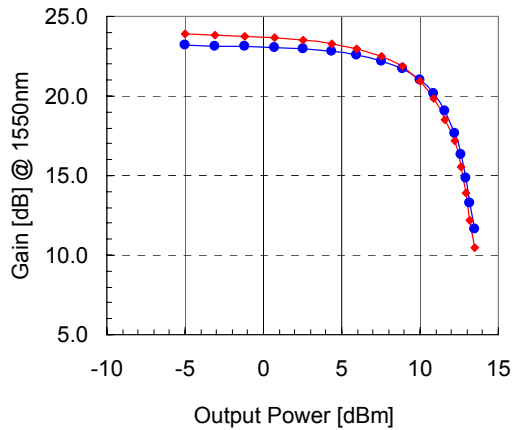

Packaging

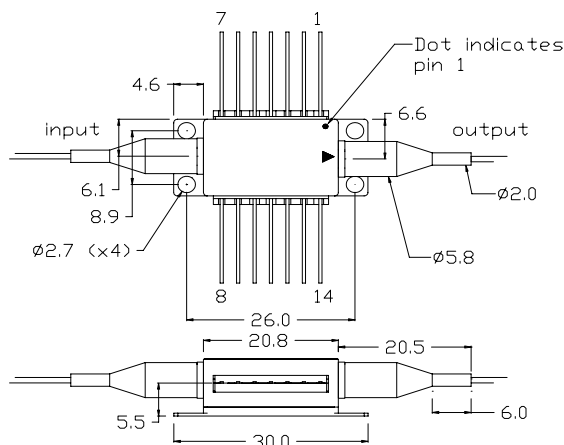

PIN IDENTIFICATION

- | | |
|---------------|-----------------|
| 1. TEC + | 14. TEC - |
| 2. Thermistor | 13. Case |
| 3. NC | 12. NC |
| 4. NC | 11. SDA Cathode |
| 5. Thermistor | 10. SDA Anode |
| 6. NC | 9. NC |
| 7. NC | 8. NC |

Recommended mounting torque is 10-20oz.in (0.07-0.14N.m).

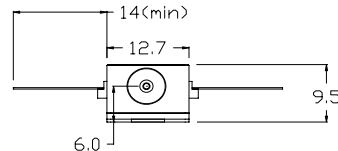

all dimensions in mm

Ordering Information

SOA 1117 - X - 0 - X - X - X - X - X							
X	0	X	X	X	X	X	Numeric
Isolator	Reserved	Fiber jacket configuration*	Input Fiber	Output Fiber	Input Connector	Output Connector	Reserved
0 = none		U = SMF-8, loose tube	S = SMF	S = SMF	A = FC/APC	A = FC/APC	0
1 = input only		T = SMF-28, tight jacket	P = PMF#	P = PMF#			
2 = output only		V = PMF 1550 nm, loose tube#					
3 = input & output							

Isolators are available only on SM fiber configurations
 * see separate fibertail options datasheet

© Covega Corporation - All rights reserved

SOA 1084: 1490 Semiconductor Optical Amplifier

7.1.2.SP.1084 Rev F

Description

COVEGA's 1084 SOA is a polarization insensitive optical amplifier for 1490 nm access optical networks.

The 1084 proprietary structure has been design for High output power and broad optical bandwidth. This amplifier is an economic alternative to boost the optical power at the transmitting end or for in-line amplification.

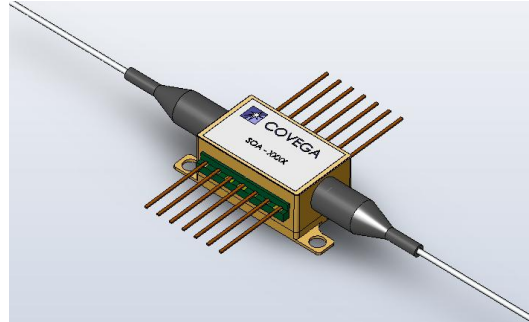

Applications

- ✓ Metro & Access Optical Networks
- ✓ Booster Amplifier
- ✓ In-Line Amplifier

Features

- High Fiber-to-Fiber Gain
- Broad Spectral Bandwidth
- High Fiber-to-Fiber Gain

Specifications

CW; T (Chip) = 25°C, T (Case) = 0 - 70°C

Parameter		Min	Typ	Max	
Operating Current	I_{OP}		600		mA
Operating Wavelength Range: SC-band	Λ	1480		1500	nm
Optical 3 dB Bandwidth	BW	70	75		nm
Saturation Output Power @ -3 dB, $\lambda = 1530$ nm	P_{SAT}	13	14		dBm
Small Signal Gain over SC-band @ $P_{in} = -20$ dBm	G_0	10	14		dB
Gain Flatness over SC-band	ΔG		5	7	dB
Gain Ripple (p-p) @ I_{OP}	δG		0.1	0.5	dB
Polarization Dependent Gain	PDG		1.0	2.0	dB
Noise Figure	NF		9	11	dB
Forward Voltage	V_F		1.5	1.8	V
TEC Operation (typ / max @ $T_{CASE} = 25^\circ C / 70^\circ C$)					
- TEC Current	I_{TEC}		0.23	1.5	A
- TEC Voltage	V_{TEC}		0.6	3.5	V
- Thermistor Resistance	R_{TH}		10K		Ω

SPECIFICATIONS ARE SUBJECT TO CHANGE WITHOUT NOTICE

The picture is a representation. The actual part may vary from the one shown.

SOA 1084

Performance

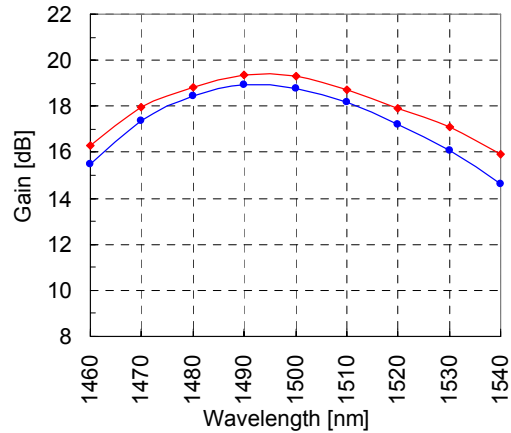
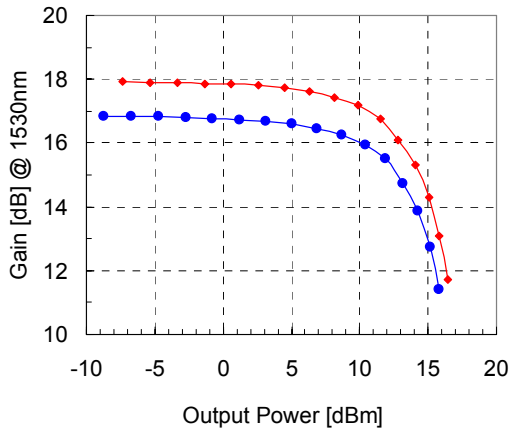

Packaging

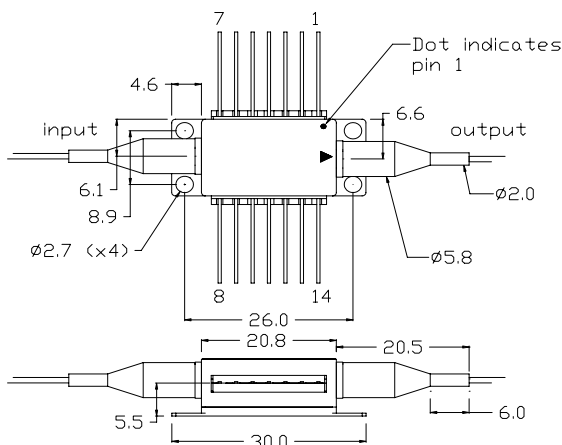

PIN IDENTIFICATION

- | | |
|---------------|-----------------|
| 1. TEC + | 14. TEC - |
| 2. Thermistor | 13. Case |
| 3. NC | 12. NC |
| 4. NC | 11. SDA Cathode |
| 5. Thermistor | 10. SDA Anode |
| 6. NC | 9. NC |
| 7. NC | 8. NC |

Recommended mounting torque is 10-20oz.in (0.07-0.14N.m).

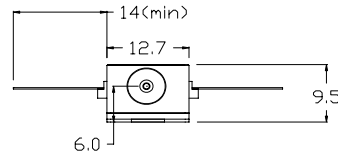

all dimensions in mm

Ordering Information

SOA 1084 - X - 0 - X - X - X - X - X

X	0	X	X	X	X	X	Numeric
Isolator	Reserved	Fiber jacket configuration*	Input Fiber	Output Fiber	Input Connector	Output Connector	Reserved
0 = none		U = SMF-8, loose tube	S = SMF	S = SMF	A = FC/APC	A = FC/APC	
1 = input only		T = SMF-28, tight jacket	P = PMF#	P = PMF#			
2 = output only		V = PMF 1550 nm, loose tube#					
3 = input & output							

Isolators are available only on SM fiber configurations

* see separate fibertail options datasheet

© Covega Corporation - All rights reserved

SOA 1085: 1550nm Semiconductor Optical Amplifier

7.1.2.SP.1085 Rev F

Description

COVEGA's 1085 SOA is a polarization insensitive semiconductor optical amplifier (SOA) for coarse wavelength division multiplexing (CWDM) metro and access optical networks.

The 1085's proprietary structure has been design for high output power and broad optical bandwidth to accommodate up to four (4) C-WDM channels in the CL-band (1543 nm - 1617 nm). This amplifier is an economic alternative to boost the optical power at the transmitting end or for in-line amplification.

The 1085 can be used in conjunction with COVEGA's 1084 that covers the CL-band to amplify up to eight (8) C-WDM channels in total.

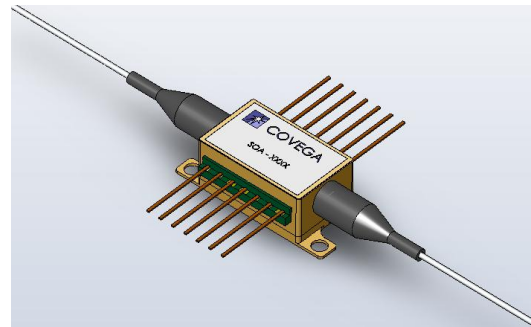

Features

Applications

- ✓ CWDM Metro & Access Optical Networks
- ✓ Booster Amplifier
- ✓ In-Line Amplifier

- Wide Bandwidth
- High Output Power
- High Fiber-to-Fiber Gain
- Low Polarization Dependent Gain

Specifications

CW; T (Chip) = 25°C, T (Case) = 0 - 70°C

Parameter		Min	Typ	Max	
Operating Current	I_{OP}		600		mA
Operating Wavelength Range: CL-band	Λ		1550		nm
Optical 3 dB Bandwidth	BW	65	75		nm
Saturation Output Power @ -3 dB	P_{SAT}	9	12		dBm
Small Signal Gain over CL-band @ $P_{in} = -20$ dBm	G	10	14		dB
Gain Flatness over CL-band	ΔG		5	7	dB
Gain Ripple (p-p) @ I_{OP}	δG		0.1	0.5	dB
Polarization Dependent Gain	PDG		1.5	3.0	dB
Noise Figure	NF		9	11	dB
Forward Voltage	V_F		1.6	1.8	V
TEC Operation (typ / max @ $T_{CASE} = 25^\circ C / 70^\circ C$)					
- TEC Current	I_{TEC}		0.23	1.5	A
- TEC Voltage	V_{TEC}		0.6	3.5	V
- Thermistor Resistance	R_{TH}		10K		Ω

SPECIFICATIONS ARE SUBJECT TO CHANGE WITHOUT NOTICE

The picture is a representation. The actual part may vary from the one shown.

SOA 1085

Performance

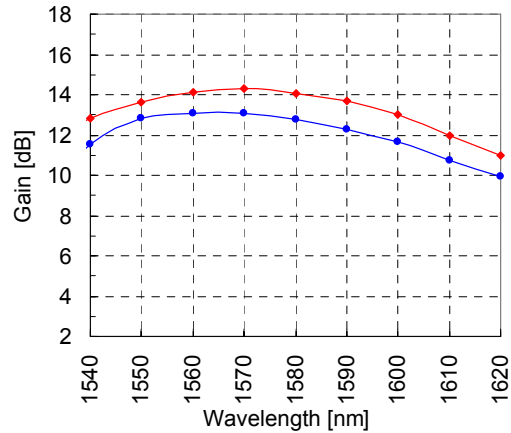
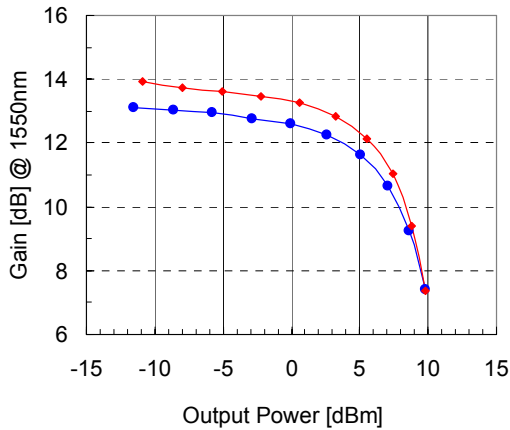

Packaging

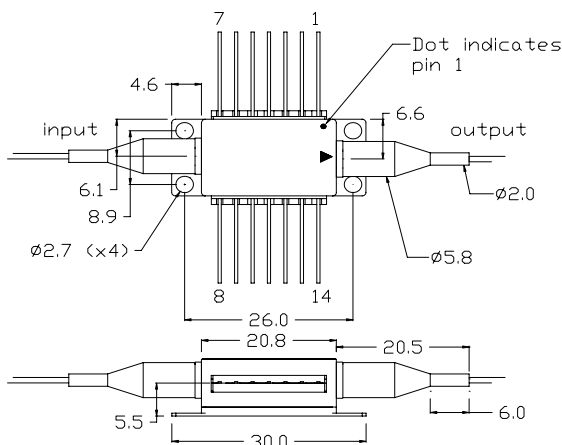

PIN IDENTIFICATION

- | | |
|---------------|-----------------|
| 1. TEC + | 14. TEC - |
| 2. Thermistor | 13. Case |
| 3. NC | 12. NC |
| 4. NC | 11. SOA Cathode |
| 5. Thermistor | 10. SOA Anode |
| 6. NC | 9. NC |
| 7. NC | 8. NC |

Recommended mounting torque is 10-20oz.in (0.07-0.14N.m).

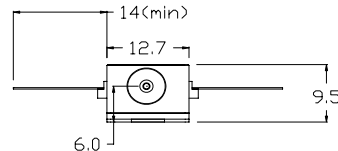

all dimensions in mm

Ordering Information

SOA 1085 - X - 0 - X - X - X - X - X							
X	0	X	X	X	X	X	Numeric
Isolator	Reserved	Fiber jacket configuration*	Input Fiber	Output Fiber	Input Connector	Output Connector	Reserved
0 = none		U = SMF-8, loose tube	S = SMF	S = SMF	A = FC/APC	A = FC/APC	
1 = input only		T = SMF-28, tight jacket	P = PMF#	P = PMF#			
2 = output only		V = PMF 1550 nm, loose tube#					
3 = input & output							

Isolators are available only on SM fiber configurations

* see separate fibertail options datasheet

© Covega Corporation - All rights reserved

FPL 1001: 1550nm Fabry-Perot Laser Chip

7.1.2.SP.1001 Rev D

Description

COVEGA's high power Fabry-Perot Laser (FPL) diode is based on state of the art quantum-well epitaxial layer growth and a reliable ridge waveguide structure. P-down bonding enables high-power operation in the eye-safe 1550 nm wavelength range.

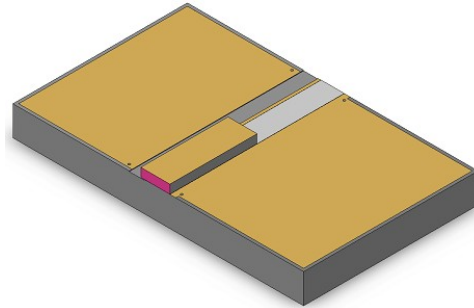

Features

Applications

- ✓ Source Laser for Free Space Optical Wireless Communication
- ✓ Laser Transmitter for Eye-safe Remote Sensing Applications

- High Optical Output Power
- High Slope Efficiency
- Numerous packaging Options

Specifications

CW; T (Chip) = 25°C, T (Case) = 0 - 70°C

Parameter		Min	Typ	Max	
Operating Current	I_{OP}		400	500	mA
Center Wavelength	λ_C	1530	1550	1570	nm
Spectral Bandwidth (rms)	$\Delta\lambda$		7	12	nm
Output Power	P_{OUT}	140	150		mW
Threshold Current	I_{TH}		35	50	mA
Slope Efficiency	$\Delta P/\Delta I$	0.4	0.5		W/A
Reflectivity (Front / Back)	R		1 / 90		%
Forward Voltage	V_F		1.4	1.6	V
Chip Length	L		1.0		mm
Beam Divergence Angle (FWHM)					
- Transverse	θ_T	28	31	34	deg
- Lateral	θ_L	16	18	20	deg

SPECIFICATIONS ARE SUBJECT TO CHANGE WITHOUT NOTICE

The picture is a representation. The actual part may vary from the one shown.

FPL 1001

Performance

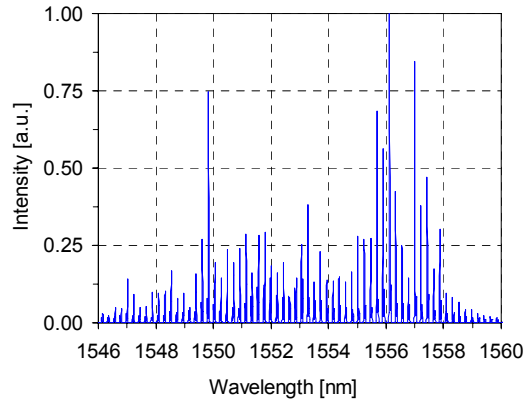
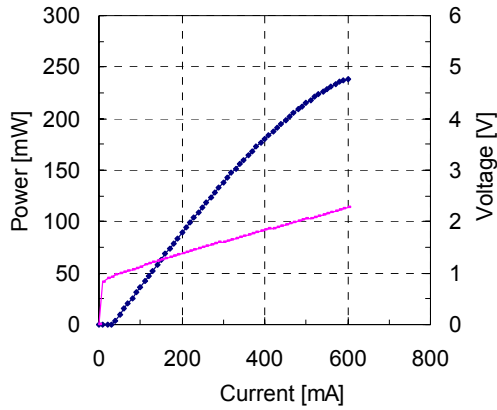

Packaging

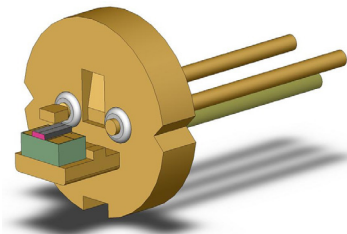
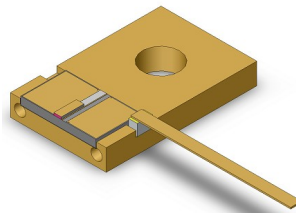
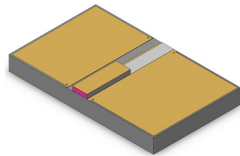

Chip on Submount

CT - Mount

TO-56 Header

Ordering Information

FPL 1001 - XXX	
XXX	
Submount	
DIE = Bare Die	
COS = Chip on Submount	
CMN = C-Mount	
CTM = CT-Mount	
* Note: expect reduced output power due to higher thermal impedance	
© Covega Corporation - All rights reserved	

FPL 1009: 1550nm Fabry-Perot Laser

7.1.2.SP.1009 Rev D

Description

COVEGA's high power Fabry-Perot Laser diode (FPL) is based on a state of the art quantum well epitaxial layer growth and reliable ridge waveguide structure. The device is housed in a high performance 14 pin butterfly package.

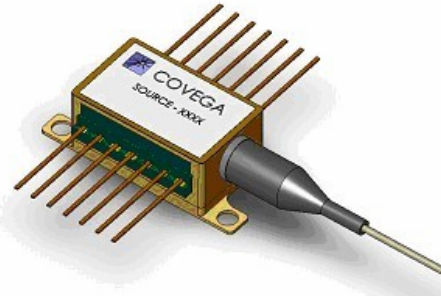

Features

Applications

- ✓ Optical Source for free space optical wireless systems
- ✓ Laser transmitter for eye-safe remote sensing applications

- High optical output power
- 14 pin Butterfly package
- Highly reliable InP ridge waveguide

Specifications

CW; T (Chip) = 25°C, T (Case) = 0 - 70°C

Parameter		Min	Typ	Max	
Operating Current	I_{OP}		400	500	mA
Center Wavelength	λ_C	1530	1550	1570	nm
Spectral Bandwidth (rms)	$\Delta\lambda$		10	20	nm
Output Power over C-Band	P_{OUT}	80	100		mW
Threshold Current	I_{TH}		35	55	mA
Slope Efficiency	$\Delta P/\Delta I$	0.2	0.30		W/A
Forward Voltage	V_F		1.4	1.6	V
TEC Operation (typ / max @ $T_{CASE} = 25^\circ C / 70^\circ C$)					
- TEC Current	I_{TEC}		0.18	1.5	A
- TEC Voltage	V_{TEC}		0.5	3.5	V
- Thermistor Resistance	R_{TH}		10K		Ω

SPECIFICATIONS ARE SUBJECT TO CHANGE WITHOUT NOTICE

The picture is a representation. The actual part may vary from the one shown.

FPL 1009

Performance

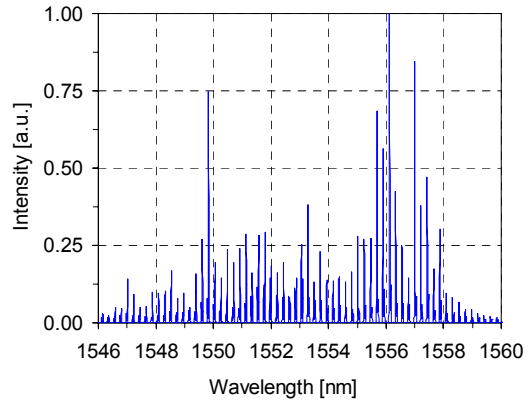
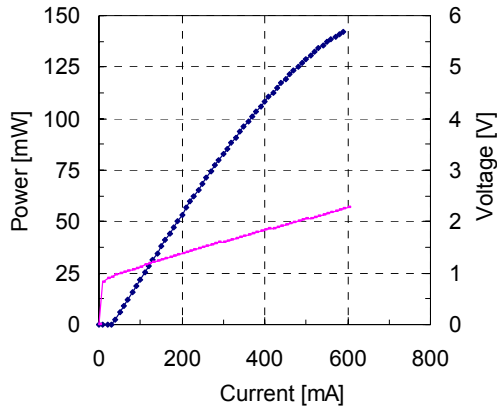

Packaging

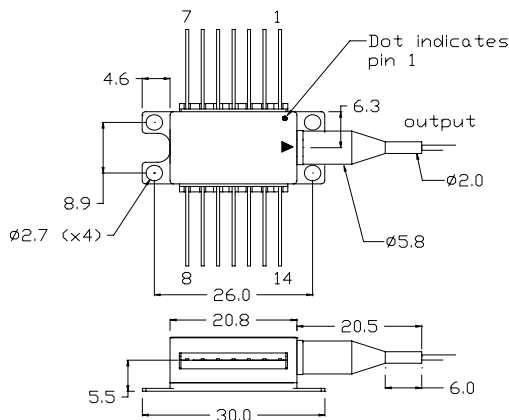

PIN IDENTIFICATION

- | | |
|---------------|-----------------|
| 1. TEC + | 14. TEC - |
| 2. Thermistor | 13. Case |
| 3. NC | 12. NC |
| 4. NC | 11. Dev Cathode |
| 5. Thermistor | 10. Dev Anode |
| 6. NC | 9. NC |
| 7. NC | 8. NC |

Recommended mounting torque is 10-20oz.in (0.07-0.14N.m).

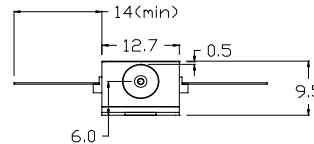

all dimensions in mm

Ordering Information

FPL 1009 - X - 0 - X - X - X					
X	0	X	X	X	Numeric
Isolator	Reserved	Fiber jacket configuration*	Fiber Type	Connector Type	Reserved
0 = none		U = SMF-28, loose tube	S = SMF	B = Bare Fiber	
2 = output only		T = SMF-28, tight jacket	P = PMF	A = FC/APC	1 = Reserved
		V = PMF 1550 nm, loose tube		O = Other	2 = Reserved

* see separate fibertail options datasheet

© Covega Corporation - All rights reserved

SAF 1126: C-band Single Angled Facet Gain Chip

7.1.2.SP.1126 Rev B

Description

COVEGA's Single Angled Facet (SAF) gain chip is a high-power InP active waveguide gain element. The proprietary SAF design produces low modal reflectance at the angled facet and optimum reflectance at the normal facet. This unique combination of ridge waveguide laser design and broadband low angled facet reflectance makes the SAF ideally suited for use as the gain component in high-power widely tunable external cavity lasers.

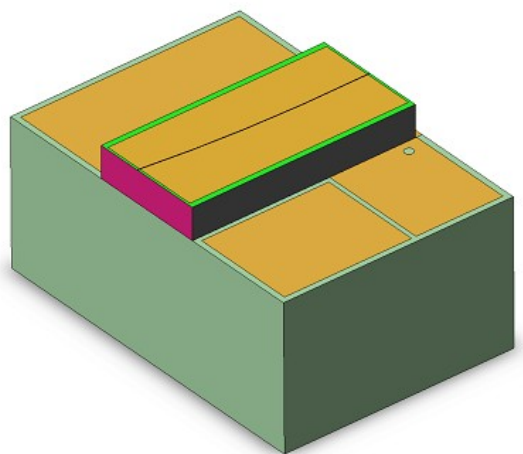

Features

Applications

- ✓ Gain medium for widely tunable external cavity semiconductor lasers
- ✓ Gain medium for narrow line-width fiber Bragg Grating Lasers.

- Broad tuning range
- High Output Power
- Low Angled Facet Reflectivity

Specifications

Specifications based on Litrow external cavity configuration and R2 = 10%; External Cavity Losses < 5 dB CW; T (Chip) = 25°C

Parameter		Min	Typ	Max	
Operating Current	I_{OP}		300	350	mA
Operating Wavelength Range: C- Band	Λ	1528		1568	nm
Threshold Current	I_{TH}		60	75	mA
Output Power over Band	P_{OUT}	40	60		mW
Side-Mode Suppression Ratio	SMSR		50		dB
Angled Facet Reflectivity	R1		0.001	0.01	%
Forward Voltage	V_F		1.3	1.8	V
Chip Length	L		1.0		mm
Lateral Beam Exit Angle	θ_{EXT}		19.5		deg
Beam Divergence Angle (FWHM)					
- Transverse	θ_T	26	30	34	deg
- Lateral	θ_L		16		deg

SPECIFICATIONS ARE SUBJECT TO CHANGE WITHOUT NOTICE

The picture is a representation. The actual part may vary from the one shown.

SAF 1126

Performance

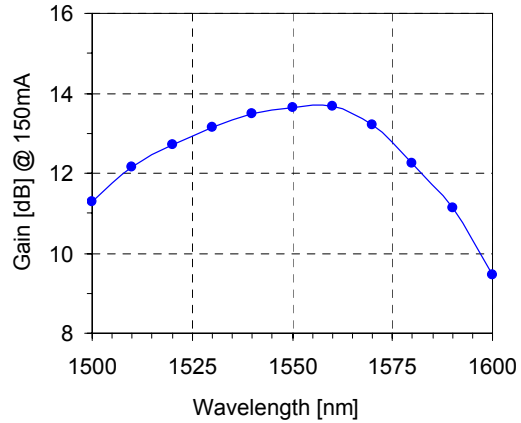
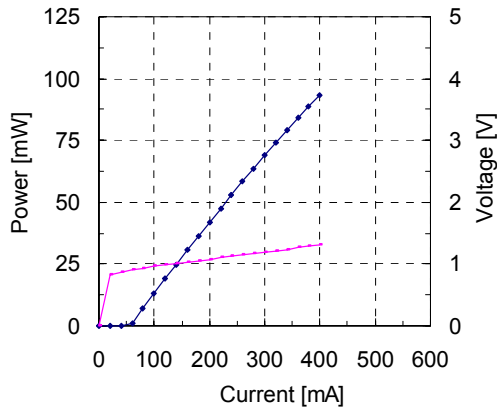

Packaging

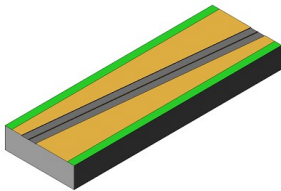
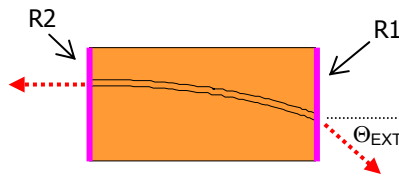

Bare Die

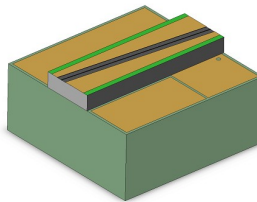

Chip on Submount

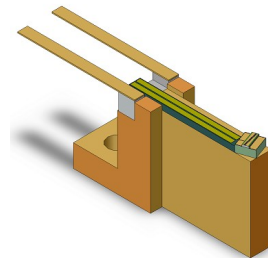

Chip on Heatsink

Ordering Information

SAF 1126 - XX - XX - XXX		
XX	XX	XXX
ECL Peak Wavelength	R2 Reflectivity	Submount
55 = 1550 nm	10 = 10%	DIE = Bare Die
57 = 1570 nm	90 = 90%	COS = Chip on Submount
ZZ = Custom	ZZ = Custom	HTS = Heatsink
		TH5 = TO-56 Header

© Covega Corporation - All rights reserved

SAF 1027: C-band Single Angled Facet Reflective Amplifier

7.1.2.SP.1027 Rev D

Preliminary Model

Description

COVEGA's Single Angled Facet (SAF) module features COVEGA's 1027 high-power InP active waveguide gain chip. The proprietary SAF design produces low modal reflectance at the angled facet and optimum reflectance at the normal facet. This unique combination of ridge waveguide laser design and broadband low angled facet reflectance makes the SAF ideally suited for use as the gain component in high-power widely tunable external cavity lasers.

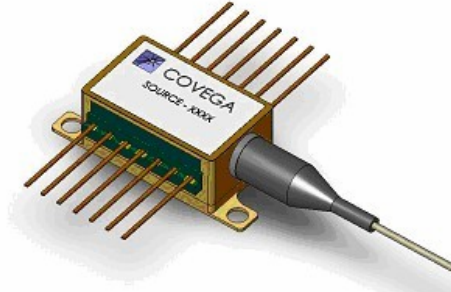

Applications

- ✓ Gain Medium for Widely Tunable External Cavity Semiconductor Lasers
- ✓ Gain Medium for Narrow Linewidth Fiber Bragg Grating Lasers

Features

- Broad tuning range
- High Output Power
- Low Front Facet Reflectivity

Specifications

Specifications based on external fiber grating configuration ($R_{\text{FBG}} = 10\%$)
 CW; T (Chip) = 25°C, T (Case) = 0 - 65°C

Parameter		Min	Typ	Max	
Operating Current	I_{OP}		300	350	mA
Operating Wavelength Range: C- Band	Δ	1528		1568	nm
Threshold Current	I_{TH}		60	75	mA
Output Power over Band	P_{OUT}	40	60		mW
Side-Mode Suppression Ratio	SMSR		40		dB
Angled Facet Reflectivity (Fiber coupled)	R1		0.001	0.01	%
Straight Facet Reflectivity	R2		90		%
Forward Voltage	V		1.4	1.8	V
TEC Operation (typ / max @ $T_{\text{CASE}} = 25^\circ\text{C} / 65^\circ\text{C}$)					
- TEC Current	I_{TEC}		0.4	1.5	A
- TEC Voltage	V_{TEC}		0.7	3.5	V
- Thermistor Resistance	R_{TH}		10K		Ω

SPECIFICATIONS ARE SUBJECT TO CHANGE WITHOUT NOTICE

Performance

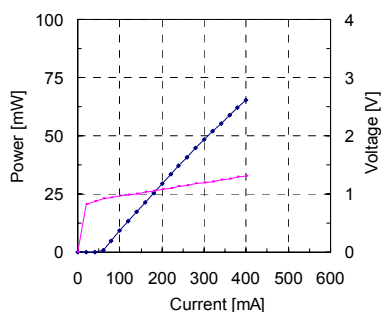

The picture is a representation. The actual part may vary from the one shown.

SAF 1027

Package drawing for base model

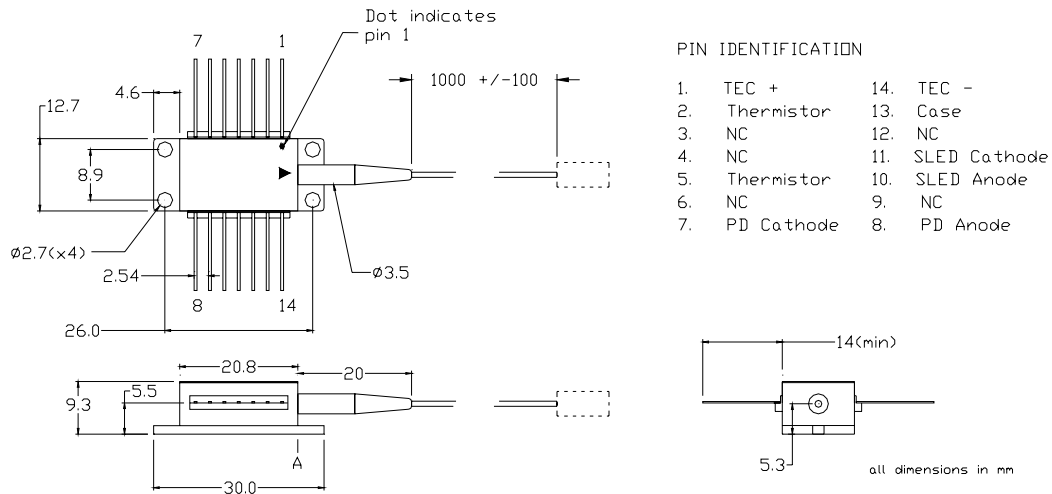

Base model configuration: SAF 1027 - XX - XX - 0 - 2 - C - S - A

+ Package drawing for options model

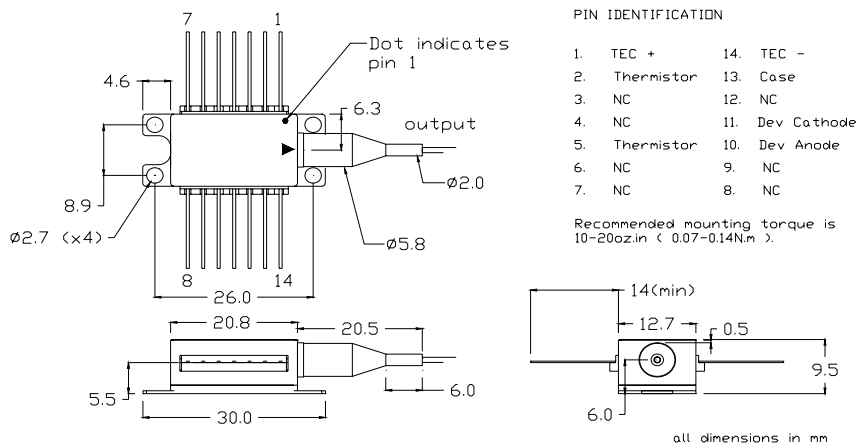

Ordering Information

SAF 1027 - XX - XX - X - 0 - X - X - X							
XX	XX	X	0	X	X	X	Numeric
Peak Wavelength	R2 Reflectivity	Isolat or	Phot odiod e	Fiber jacket configuration*	Fiber Type	Connector type	Reserved
55 = 1550 nm	90 = 90%	0 = none	0 = N/A	U = SMF-28, loose tube	S = SMF	B = Bare Fiber	
ZZ = custom	ZZ = Custom	2 = output		T = SMF-28, tight jacket	P = PMF	A = FC/APC	1 = Reserved
				V = PMF 1550 nm, loose tube		O = Other	2 = Reserved
				C = reserved			

* see separate fibertail options datasheet

SAF 1118: L-band Single Angled Facet Gain Chip

7.1.2.SP.1118 Rev B

Description

COVEGA's Single Angled Facet (SAF) gain chip is a high-power InP active waveguide gain element. The proprietary SAF design produces low modal reflectance at the angled facet and optimum reflectance at the normal facet. This unique combination of ridge waveguide laser design and broadband low angled facet reflectance makes the SAF ideally suited for use as the gain component in high-power widely tunable external cavity lasers.

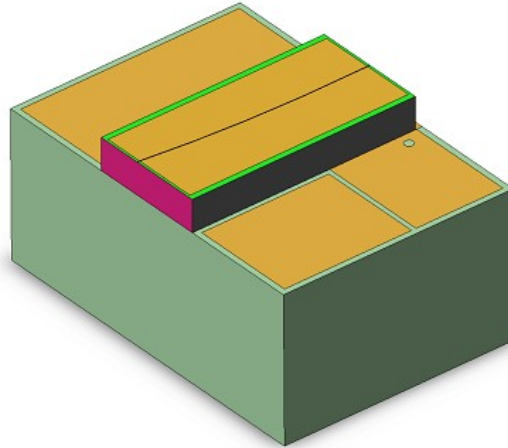

Applications

- ✓ Gain medium for widely tunable external cavity semiconductor lasers
- ✓ Gain medium for narrow line-width fiber Bragg Grating Lasers.

Features

- Broad tuning range
- High Output Power
- Low Angled Facet Reflectivity

Specifications

Specifications based on Litrow external cavity configuration and R2 = 10%; External Cavity Losses < 5 dB CW; T (Chip) = 25°C

Parameter		Min	Typ	Max	
Operating Current	I_{OP}		300	350	mA
Operating Wavelength Range: L - Band	Δ	1568		1608	nm
Threshold Current	I_{TH}		60	75	mA
Output Power over Band	P_{OUT}	40	60		mW
Side-Mode Suppression Ratio	SMSR		50		dB
Angled Facet Reflectivity	R1		0.001	0.01	%
Forward Voltage	V_F		1.3	1.8	V
Chip Length	L		1.0		mm
Lateral Beam Exit Angle	θ_{EXT}		19.5		deg
Beam Divergence Angle (FWHM)					
- Transverse	θ_T	26	30	34	deg
- Lateral	θ_L		16		deg

SPECIFICATIONS ARE SUBJECT TO CHANGE WITHOUT NOTICE

The picture is a representation. The actual part may vary from the one shown.

SAF 1118

Performance

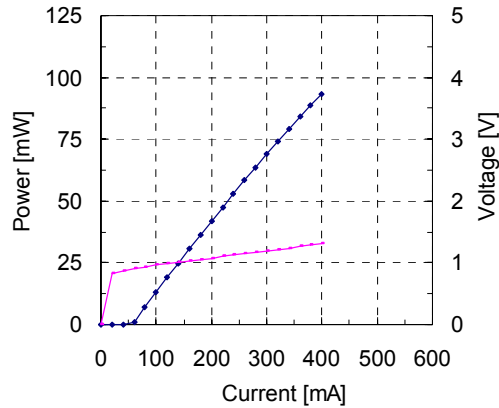

Packaging

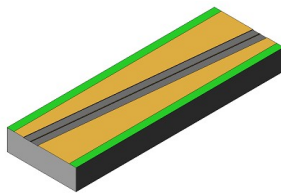
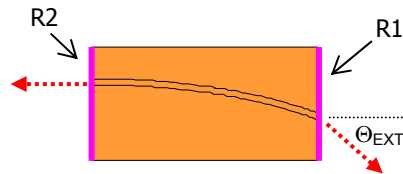

Bare Die

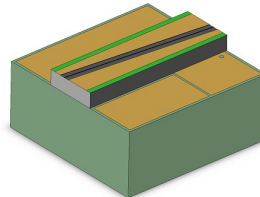

Chip on Submount

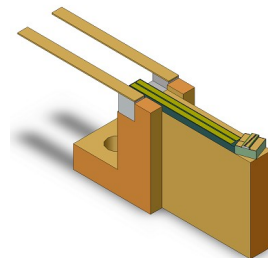

Chip on Heatsink

Ordering Information

SAF 1118 - XX - XX - XXX			
XX	XX	XXX	
ECL Peak Wavelength	R2 Reflectivity	Submount	
61 = 1610 nm	10 = 10%	DIE = Bare Die	
ZZ = Custom	90 = 90%	COS = Chip on Submount	
	ZZ = Custom	HTS = Heatsink	
		TH5 = TO-56 Header	

© Covega Corporation - All rights reserved

SAF 1120: L-band Single Angled Facet Reflective Amplifier

7.1.2.SP.1120 Rev C

Preliminary Model

Description

COVEGA's Single Angled Facet (SAF) module features COVEGA's 1120 high-power InP active waveguide gain chip. The proprietary SAF design produces low modal reflectance at the angled facet and optimum reflectance at the normal facet. This unique combination of ridge waveguide laser design and broadband low angled facet reflectance makes the SAF ideally suited for use as the gain component in high-power widely tunable external cavity lasers.

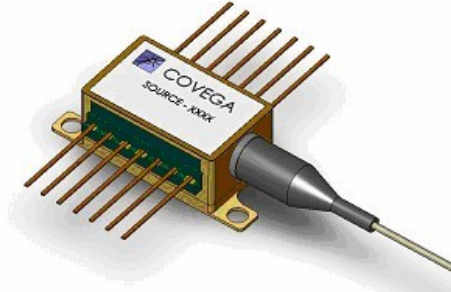

Features

Applications

- ✓ Gain Medium for Widely Tunable External Cavity Semiconductor Lasers
 - ✓ Gain Medium for Narrow Linewidth Fiber Bragg Grating Lasers
- Broad tuning range
 - High Output Power
 - Low Front Facet Reflectivity

Specifications

Specifications based on external fiber grating configuration ($R_{\text{FBG}} = 10\%$)
 CW; T (Chip) = 25°C, T (Case) = 0 - 65°C

Parameter		Min	Typ	Max	
Operating Current	I_{OP}		300	350	mA
Operating Wavelength Range: L- Band	Δ	1568		1608	nm
Threshold Current	I_{TH}		60	75	mA
Output Power over Band	P_{OUT}	40	60		mW
Side-Mode Suppression Ratio	SMSR		40		dB
Relative Intensity Noise	RIN				dB/Hz
Angled Facet Reflectivity (Fiber coupled)	R1		0.001	0.01	%
Straight Facet Reflectivity	R2		90		%
Forward Voltage	V		1.7	2.0	V
TEC Operation (typ / max @ $T_{\text{CASE}} = 25^\circ\text{C} / 65^\circ\text{C}$)					
- TEC Current	I_{TEC}		0.4	1.5	A
- TEC Voltage	V_{TEC}		0.7	3.5	V
- Thermistor Resistance	R_{TH}		10K		Ω

SPECIFICATIONS ARE SUBJECT TO CHANGE WITHOUT NOTICE

Performance

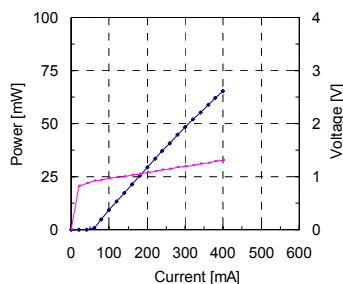

The picture is a representation. The actual part may vary from the one shown.

SAF 1120

Package drawing for base model

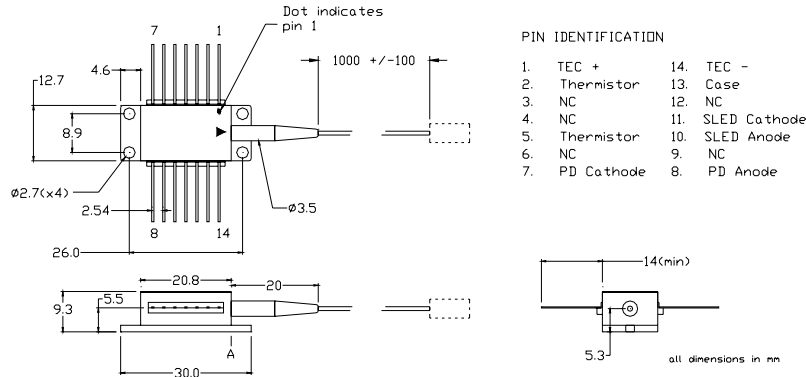

Base model configuration: SAF 1027 - XX - XX - 0 - 2 - C - S - A - X

+ Package drawing for options model

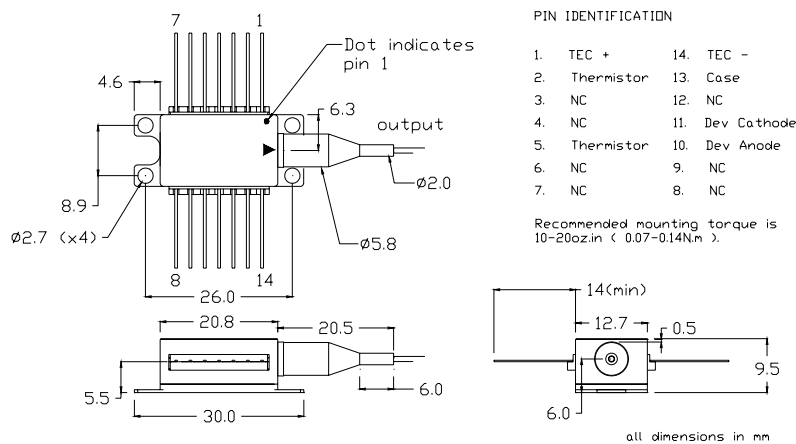

Ordering Information for option model

SAF 1120 - XX - XX - X - 0 - X - X - X							
XX	XX	X	0	X	X	X	X
Peak Wave length	R2 Reflectivity	Isolator	Photodiode	Fiber jacket configuration*	Fiber Type	Connect or type	Reserved
61 = 1610 nm	90 = 90%	0 = none	0 = N/A	U = SMF-28, loose tube	S = SMF	B = Bare Fiber	1 = Reserved
ZZ = Custom	ZZ = Custom	2 = output		T = SMF-28, tight jacket	P = PMF	A = FC/APC	2 = Reserved
				V = PMF 1550 nm, loose tube		O = Other	
				C = Reserved			

* see separate fibertail options datasheet

BAL 1113: 1450nm / 0.5W Broad Area Laser Diode Chip

7.1.2.SP.1113 Rev B

Preliminary Model

Description

COVEGA's broad area laser diode is based on a highly efficient InP/InGaAsP Quantum Well (QW) layer structure.

Advanced MBE epitaxial wafer growth techniques and die bonding processes enable reliable high-power laser diode operation.

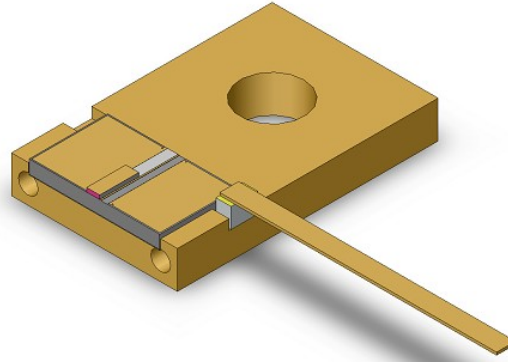

Features

Applications

- ✓ Medical
- ✓ Industrial
- ✓ Source Laser for Free Space Optical Wireless Communication

- High Optical Output Power
- High Slope Efficiency
- Numerous Packaging Options

Specifications

CW, T (Chip) = 25°C

Parameter		Min	Typ	Max	
Operating Current	I_{OP}		1.7	2.2	A
Center Wavelength	λ_C	1425	1450	1475	nm
Spectral Bandwidth (rms)	$\Delta\lambda$		7	15	nm
Output Power over C-Band	P_{OUT}	0.5			W
Threshold Current	I_{TH}		0.4	0.7	A
Slope Efficiency	$\Delta P/\Delta I$	0.3	0.5		W/A
Forward Voltage	V		3.0	4.0	V
Chip Length	L		0.6		mm
Emitter Width	W		100		μm
Beam Divergence Angle (FWHM)					
- Transverse	θ_T		28	36	deg
- Lateral	θ_L		8	14	deg

SPECIFICATIONS ARE SUBJECT TO CHANGE WITHOUT NOTICE

The picture is a representation. The actual part may vary from the one shown.

BAL 1113

Performance

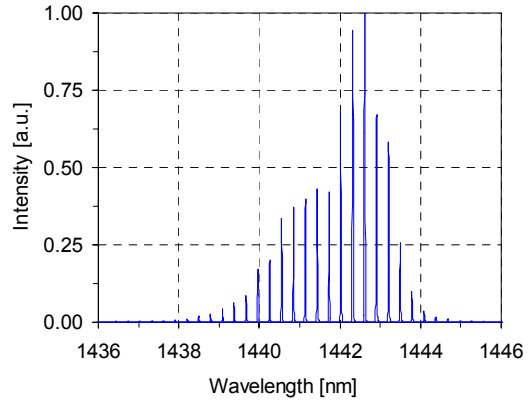
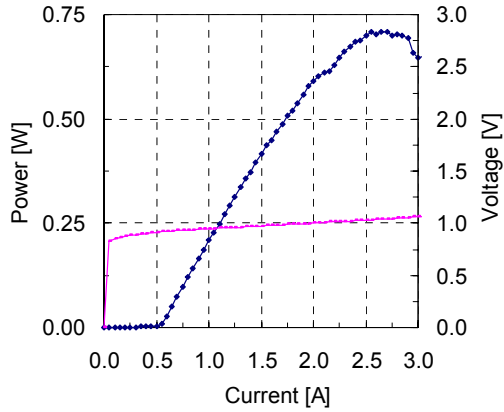

Packaging

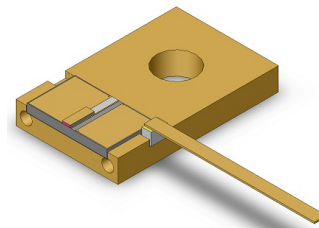
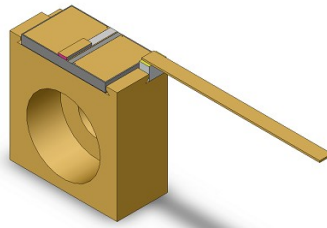
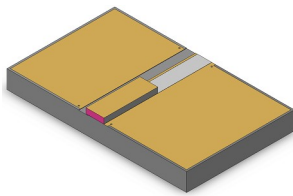

Chip on Submount

C-Mount

CT-Mount

Ordering Information

BAL 1113 - XXX	
XXX	
Submount	
COS = Chip on submount	
CMN = C-Mount	
CTM = CT-Mount	
ZZZ = Custom Mount	

© Covega Corporation - All rights reserved

BAL 1114: 1450nm / 1.0W Broad Area Laser Diode Chip

7.1.2.SP.1114 Rev B

Preliminary Model

Description

COVEGA's broad area laser diode is based on a highly efficient InP/InGaAsP Quantum Well (QW) layer structure.

Advanced MBE epitaxial wafer growth techniques and die bonding processes enable reliable high-power laser diode operation.

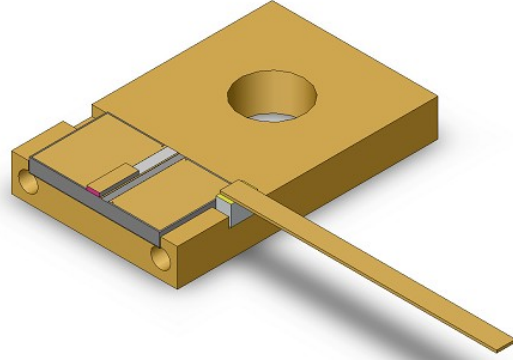

Features

Applications

- ✓ Medical
- ✓ Industrial
- ✓ Source Laser for Free Space Optical Wireless Communication

- High Optical Output Power
- High Slope Efficiency
- Numerous Packaging Options

Specifications

CW, T (Chip) = 25°C

Parameter		Min	Typ	Max	
Operating Current	I_{OP}		3.5	4.2	A
Center Wavelength	λ_C	1425	1450	1475	nm
Spectral Bandwidth (rms)	$\Delta\lambda$		8	15	nm
Output Power	P_{OUT}	1.0			W
Threshold Current	I_{TH}		0.7	0.9	A
Slope Efficiency	$\Delta P/\Delta I$	0.3	0.5		W/A
Forward Voltage	V		3	4	V
Chip Length	L		1.0		mm
Emitter Width	W		100		μm
Beam Divergence Angle (FWHM)					
- Transverse	θ_T		28	36	deg
- Lateral	θ_L		8	14	deg

SPECIFICATIONS ARE SUBJECT TO CHANGE WITHOUT NOTICE

The picture is a representation. The actual part may vary from the one shown.

BAL 1114

Performance

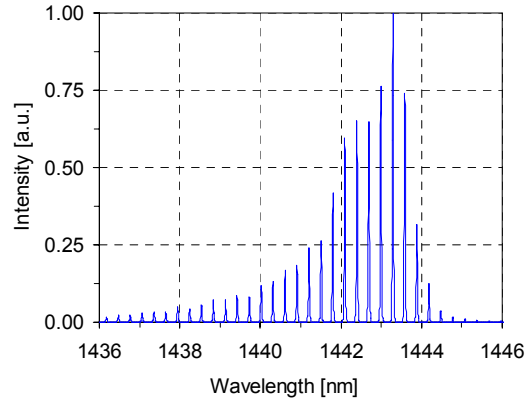
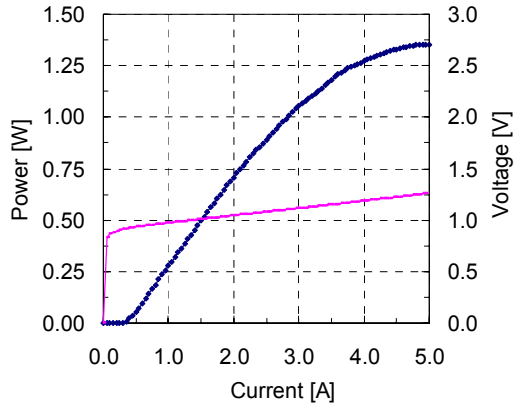

Packaging

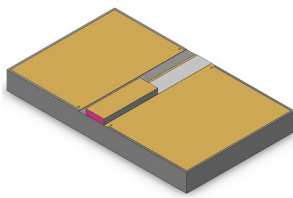

Chip on Submount

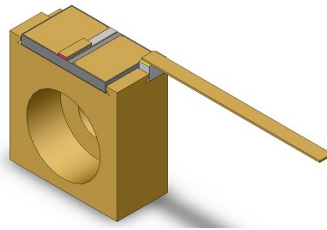

C-Mount

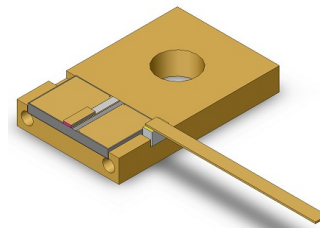

CT-Mount

Ordering Information

BAL 1114 - XXX	
XXX	
Submount	
COS = Chip on submount	
CMN = C-Mount	
CTM = CT-Mount	
ZZZ = Custom Mount	

© Covega Corporation - All rights reserved

BAL 1115: 1600nm / 0.5W Broad Area Laser Diode Chip

7.1.2.SP.1115 Rev B

Preliminary Model

Description

COVEGA's broad area laser diode is based on a highly efficient InP/InGaAsP Quantum Well (QW) layer structure.

Advanced MBE epitaxial wafer growth techniques and die bonding processes enable reliable high-power laser diode operation.

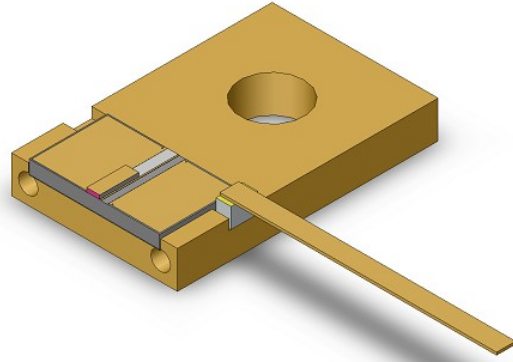

Features

Applications

- ✓ Medical
- ✓ Industrial
- ✓ Source Laser for Free Space Optical Wireless Communication

- High Optical Output Power
- High Slope Efficiency
- Numerous Packaging Options

Specifications

CW, T (Chip) = 25°C

Parameter		Min	Typ	Max	
Operating Current	I_{OP}		1.7	2.2	A
Center Wavelength	λ_C	1580	1600	1620	nm
Spectral Bandwidth (rms)	$\Delta\lambda$		7	14	nm
Output Power	P_{OUT}	0.5			W
Threshold Current	I_{TH}		0.5	0.8	A
Slope Efficiency	$\Delta P/\Delta I$	0.3	0.4		W/A
Forward Voltage	V		3	4	V
Chip Length	L		0.6		mm
Emitter Width	W		100		μm
Beam Divergence Angle (FWHM)					
- Transverse	θ_T		28	36	deg
- Lateral	θ_L		8	14	deg

SPECIFICATIONS ARE SUBJECT TO CHANGE WITHOUT NOTICE

The picture is a representation. The actual part may vary from the one shown.

BAL 1115

Performance

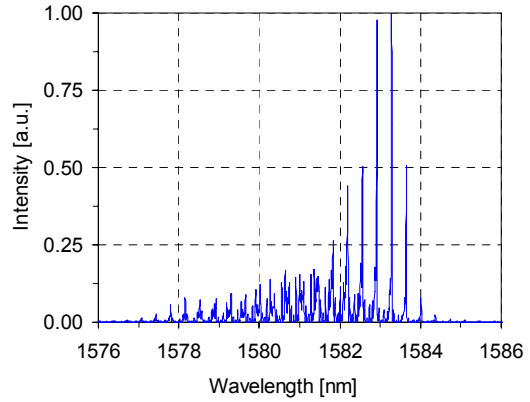
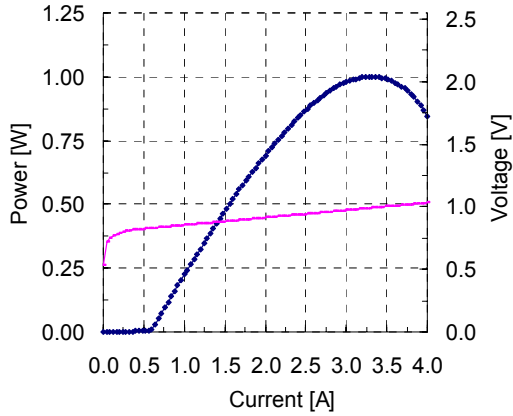

Packaging

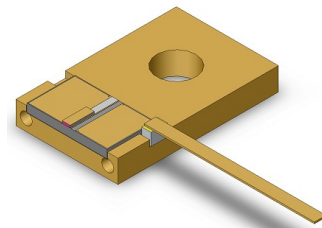
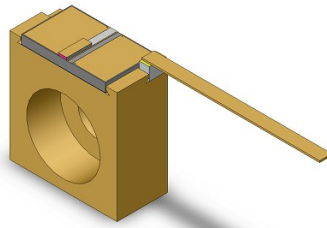
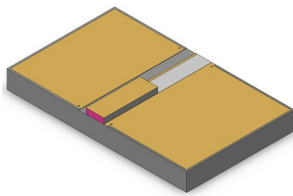

Chip on Submount

C-Mount

CT-Mount

Ordering Information

BAL 1115 - XXX	
XXX	
Submount	
COS = Chip on submount	
CMN = C-Mount	
CTM = CT-Mount	
ZZZ = Custom Mount	

© Covega Corporation - All rights reserved

BAL 1116: 1600nm / 1.0W Broad Area Laser Diode Chip

7.1.2.SP.1116 Rev B

Preliminary Model

Description

COVEGA's broad area laser diode is based on a highly efficient InP/InGaAsP Quantum Well (QW) layer structure.

Advanced MBE epitaxial wafer growth techniques and die bonding processes enable reliable high-power laser diode operation.

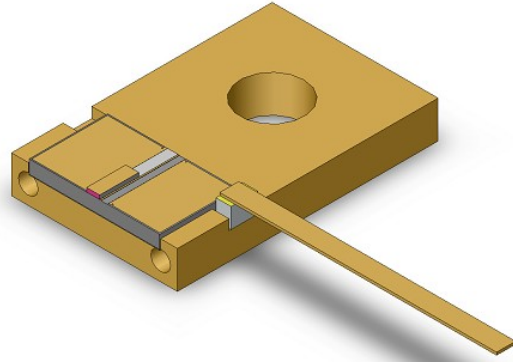

Features

Applications

- ✓ Medical
- ✓ Industrial
- ✓ Source Laser for Free Space Optical Wireless Communication

- High Optical Output Power
- High Slope Efficiency
- Numerous Packaging Options

Specifications

CW, T (Chip) = 25°C

Parameter		Min	Typ	Max	
Operating Current	I_{OP}		3.5	4.2	A
Center Wavelength	λ_C	1580	1600	1620	nm
Spectral Bandwidth (rms)	$\Delta\lambda$		8	16	nm
Output Power	P_{OUT}	1.0			W
Threshold Current	I_{TH}		0.65	0.9	A
Slope Efficiency	$\Delta P/\Delta I$	0.3	0.4		W/A
Forward Voltage	V		3	4	V
Chip Length	L		1.0		mm
Emitter Width	W		100		μm
Beam Divergence Angle (FWHM)					
- Transverse	θ_T		28	36	deg
- Lateral	θ_L		8	14	deg

SPECIFICATIONS ARE SUBJECT TO CHANGE WITHOUT NOTICE

The picture is a representation. The actual part may vary from the one shown.

BAL 1116

Performance

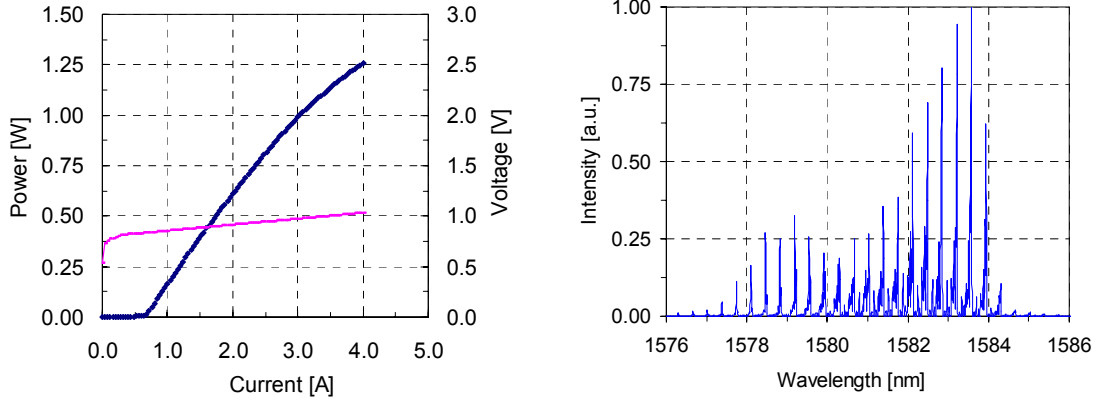

Packaging

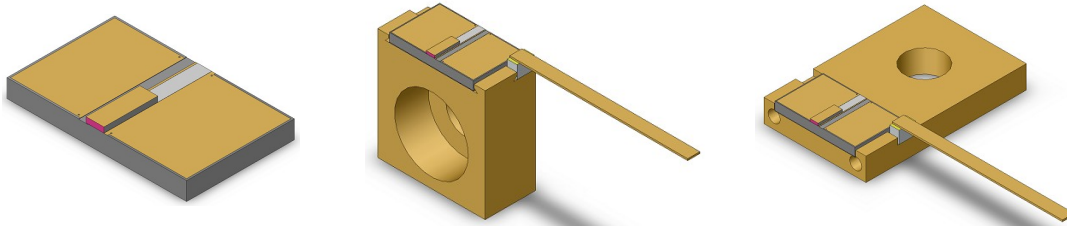

Chip on Submount

C-Mount

CT-Mount

Ordering Information

BAL 1116 - XXX	
XXX	
Submount	
COS = Chip on submount	
CMN = C-Mount	
CTM = CT-Mount	
ZZZ = Custom Mount	

© Covega Corporation - All rights reserved

SLD 1123: 1280nm / 1mW Super Luminescent Diode

7.1.2.SP.1123 Rev B

Engineering Model

Description

The SLD 1123 is a 1280 nm low power, broadband Super Luminescent Diode (SLD) with near Gaussian spectral profile and low ripple.

It is housed in a standard 14-pin dual in line (DIL) package with integrated thermoelectric cooler, thermistor and Photodiode coupled to a single mode fiber output fiber tail.

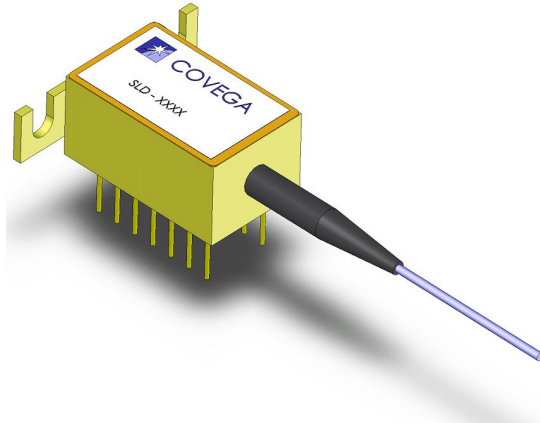

Features

Applications

- ✓ Telecom and Datacom
- ✓ Sensors
- ✓ Fiber Optic Gyros
- ✓ Instrumentation

- Low Output Power
- Broad Optical Bandwidth
- Near Gaussian Spectrum
- Low Ripple

Specifications

CW; T (Chip) = 25°C, T (Case) = 0 - 65°C

Parameter		Min	Typ	Max	
Operating Current	I_{OP}		500	600	mA
Center Wavelength	λ_C	1260	1280	1300	nm
ASE Power @ I_{OP}	P_{ASE}	1	1.5		mW
Optical Bandwidth	BW	75	95		nm
Gain Ripple (rms) @ I_{OP} , Res. BW = 0.1 nm	δG			0.25	dB
Forward Voltage @ I_{OP}	V_F		1.6	2.0	V
Photodiode Sensitivity @ $V_{PD} = -5V$	S_{PD}	0.05	0.1	0.8	A/W
TEC Operation (typ / max @ $T_{CASE} = 25^\circ C / 65^\circ C$)					
- TEC Current	I_{TEC}		0.35	1.5	A
- TEC Voltage	V_{TEC}		0.6	3.5	V
- Thermistor Resistance	R_{TH}		10K		Ω
SPECIFICATIONS ARE SUBJECT TO CHANGE WITHOUT NOTICE					

The picture is a representation. The actual part may vary from the one shown.

SLD 1123

Performance

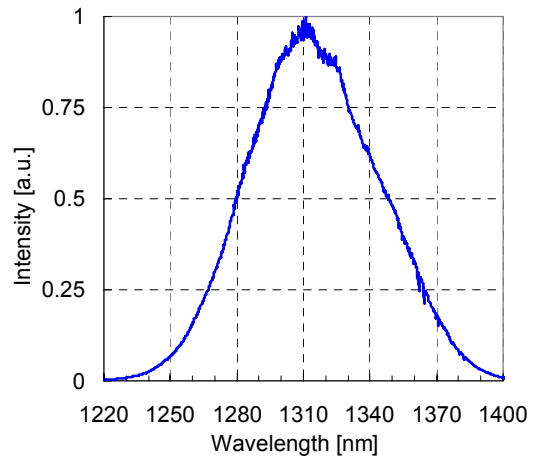
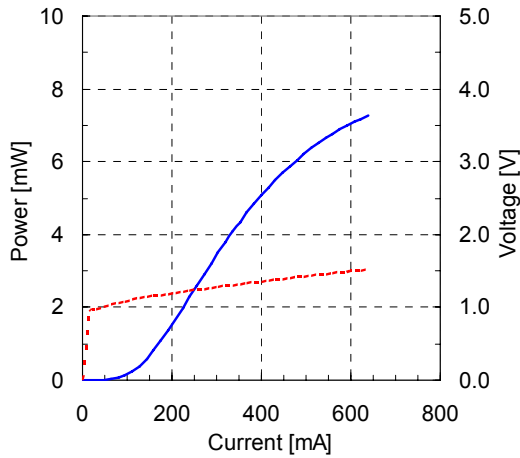

Package drawing

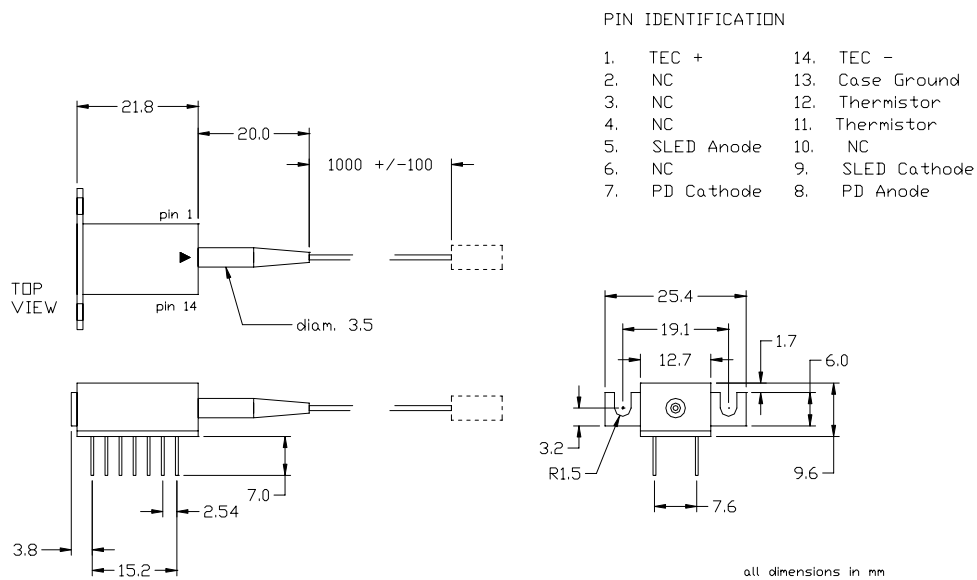

Ordering Information

SLD 1123 - 0 - 2 - C - S - A					
0	2	C	S	A	Numeric
Isolator	Photodiode	Fiber jacket configuration*	Fiber Type	Connector type	Reserved
0 = N/A	2 = included	C = Tight jacket coating	S = SMF	A = FC/APC	1 = Reserved
					2 = Reserved

* see separate fibertail options datasheet

© Covega Corporation - All rights reserved

SLD 1023: 1280nm / 10mW Super Luminescent Diode

7.1.2.SP.1023 Rev C

Description

The SLD 1023 is a 1280 nm high power, broadband Super Luminescent Diode (SLD) with near Gaussian spectral profile and low ripple.

It is housed in a standard 14 pin butterfly package with integrated thermoelectric cooler and thermistor. Packaging options include isolator and choice of single mode fiber and polarization maintaining output fiber tails.

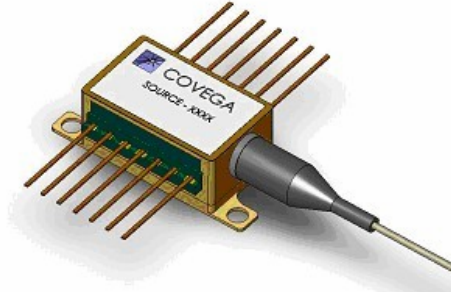

Features

Applications

- ✓ Medical, Optical Coherence Tomography
- ✓ Telecom and Datacom
- ✓ Sensors
- ✓ Fiber Optic Gyros
- ✓ Instrumentation

- High Output Power
- Broad Optical Bandwidth
- Near Gaussian Spectrum
- Low Ripple

Specifications

CW; T (Chip) = 25°C, T (Case) = 0 - 65°C

Parameter		Min	Typ	Max	
Operating Current	I_{OP}		600	800	mA
Center Wavelength	λ_C	1270	1280	1290	nm
ASE Power @ I_{OP}	P_{ASE}	10	15		mW
Optical Bandwidth	BW	40	45		nm
Gain Ripple (rms) @ I_{OP} , Res. BW = 0.1 nm	δG			0.35	dB
Forward Voltage @ I_{OP}	V_F		1.4	2.0	V
TEC Operation (typ / max @ $T_{CASE} = 25^\circ C / 65^\circ C$)					
- TEC Current Base model / Option model	I_{TEC}		0.3	1.5	A
- TEC Voltage Base model / Option model	V_{TEC}		0.6	3.5	V
- Thermistor Resistance	R_{TH}		10K		Ω

SPECIFICATIONS ARE SUBJECT TO CHANGE WITHOUT NOTICE

The picture is a representation. The actual part may vary from the one shown.

SLD 1023

Performance

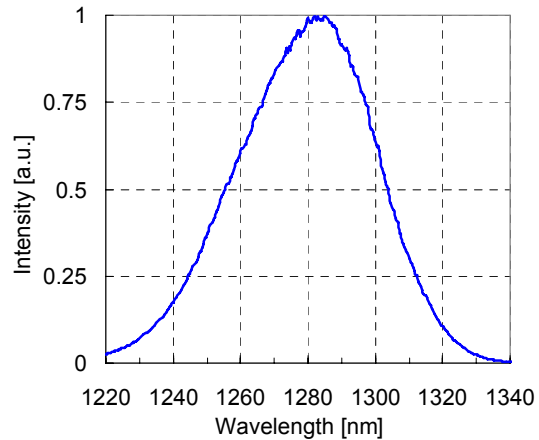
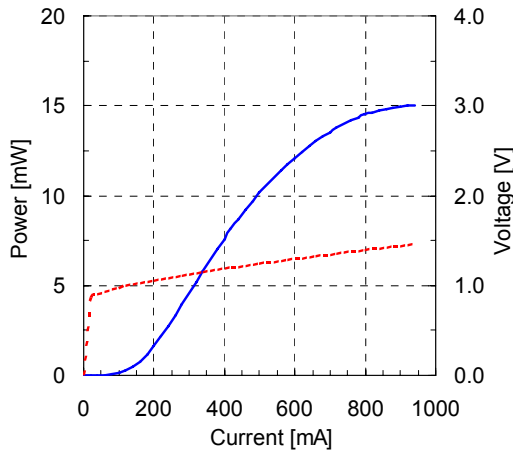

Package drawing

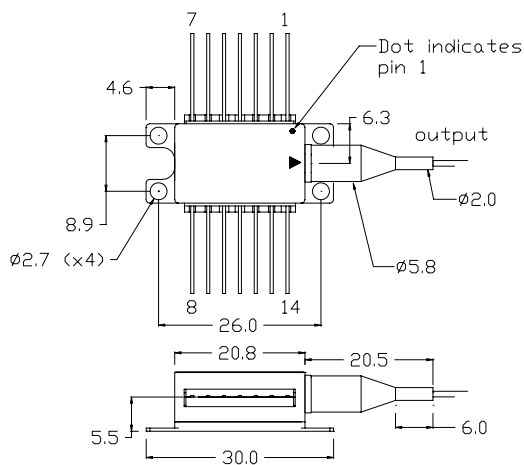

PIN IDENTIFICATION

- | | |
|---------------|-----------------|
| 1. TEC + | 14. TEC - |
| 2. Thermistor | 13. Case |
| 3. NC | 12. NC |
| 4. NC | 11. Dev Cathode |
| 5. Thermistor | 10. Dev Anode |
| 6. NC | 9. NC |
| 7. NC | 8. NC |

Recommended mounting torque is 10-20oz.in (0.07-0.14N.m).

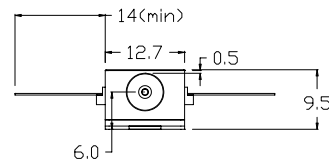

all dimensions in mm

Ordering Information

SLD 1023 - X - 0 - X - X - X					
X	0	X	X	X	Numeric
Isolator	Photodiode	Fiber jacket configuration*	Fiber Type	Connector type	Reserved
0 = none	0 = N/A	U = SMF-8, loose tube	S = SMF	B = Bare Fiber	
2 = output		T = SMF-28, tight jacket	P = PMF	A = FC/APC	1 = Reserved
		W = PMF 1300 nm, loose tube		O = Other	2 = Reserved
		C = reserved			

* see separate fibertail options datasheet

© Covega Corporation - All rights reserved

SLD 1029: 1280nm / 10mW Super Luminescent Diode

7.1.2.SP.1029 Rev C

Description

The SLD 1029 is a 1280 nm high power, broadband Super Luminescent Diode (SLD) with near Gaussian spectral profile and low ripple.

It is housed in a standard 14 pin dual in line (DIL) package with integrated thermoelectric cooler, thermistor and Photodiode coupled to a single mode fiber output fiber tail.

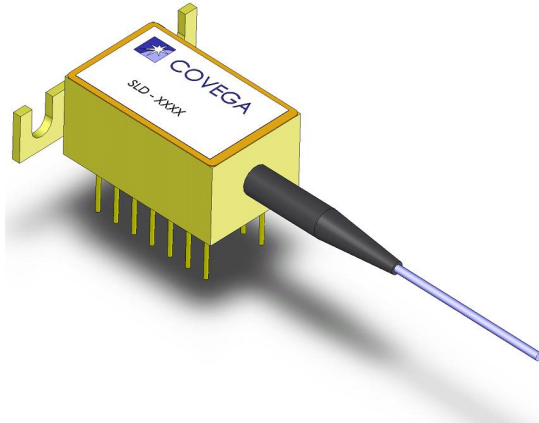

Features

Applications

- ✓ Medical, Optical Coherence Tomography
- ✓ Telecom and Datacom
- ✓ Sensors
- ✓ Fiber Optic Gyros
- ✓ Instrumentation

- High Output Power
- Broad Optical Bandwidth
- Near Gaussian Spectrum
- Low Ripple

Specifications

CW; T (Chip) = 25°C, T (Case) = 0 - 65°C

Parameter		Min	Typ	Max	
Operating Current	I_{OP}		500	650	mA
Center Wavelength	λ_C	1270	1280	1290	nm
ASE Power @ I_{OP}	P_{ASE}	10	15		mW
Optical Bandwidth	BW	35	40		nm
Gain Ripple (rms) @ I_{OP} , Res. BW = 0.1 nm	δG			0.35	dB
Forward Voltage @ I_{OP}	V_F		1.3	2.0	V
Photodiode Sensitivity @ $V_{PD} = -5V$	S_{PD}	0.05	0.1	0.8	A/W
TEC Operation (typ / max @ $T_{CASE} = 25^\circ C / 65^\circ C$)					
- TEC Current	I_{TEC}		0.3	1.5	A
- TEC Voltage	V_{TEC}		0.6	3.5	V
- Thermistor Resistance	R_{TH}		10K		Ω

SPECIFICATIONS ARE SUBJECT TO CHANGE WITHOUT NOTICE

The picture is a representation. The actual part may vary from the one shown.

SLD 1029

Performance

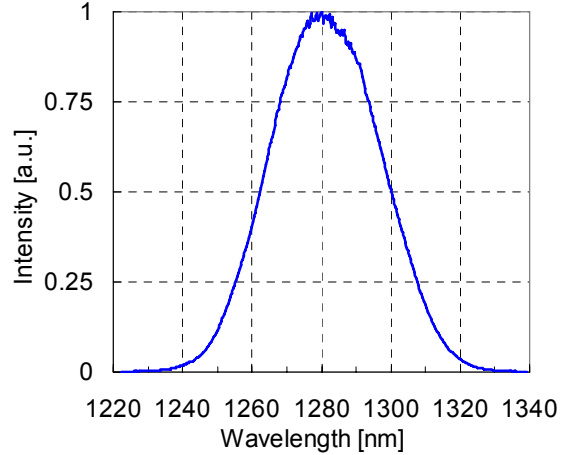
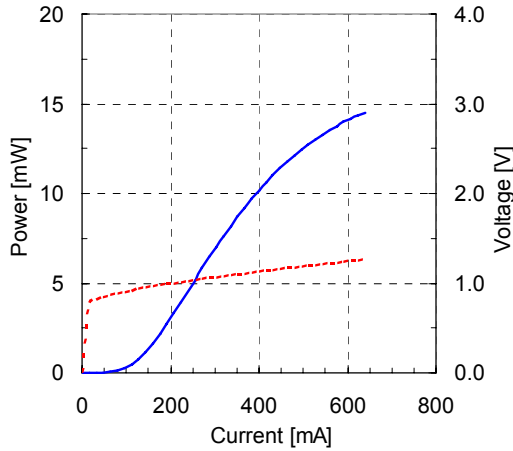

Package drawing

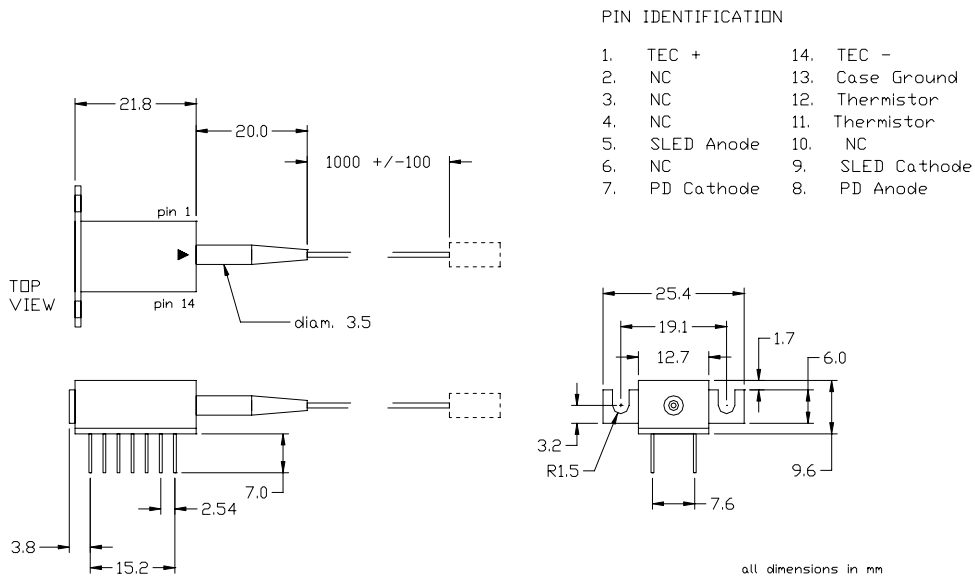

Ordering Information

SLD 1029 - 0 - 2 - C - S - A					
0	2	C	S	A	Numeric
Isolator	Photodiode	Fiber jacket configuration*	Fiber Type	Connector type	Reserved
0 = N/A	2 = included	C = Tight jacket coating	S = SMF	A = FC/APC	1 = Reserved
					2 = Reserved
* see separate fibertail options datasheet					

© Covega Corporation - All rights reserved

SLD 1105: 1310 nm / 5mW Super Luminescent Diode

7.1.2.SP.1105 Rev C

Description

The SLD 1105 is a 1310 nm medium power, broadband Super Luminescent Diode (SLD) with near Gaussian spectral profile and low ripple.

It is housed in a standard 14-pin dual in line (DIL) package with integrated thermoelectric cooler, thermistor and Photodiode coupled to a single mode fiber output fiber tail.

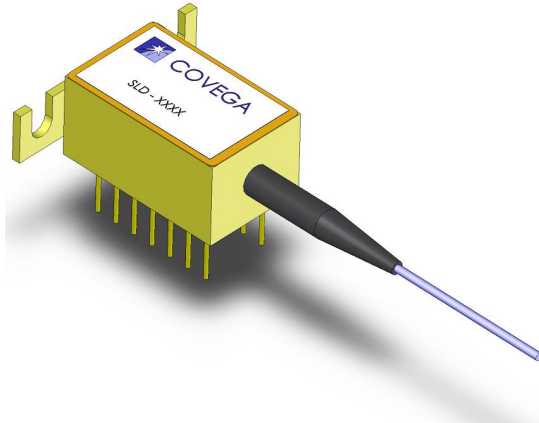

Features

Applications

- ✓ Medical, Optical Coherence Tomography
- ✓ Telecom and Datacom
- ✓ Sensors
- ✓ Fiber Optic Gyros
- ✓ Instrumentation

- Medium Output Power
- Broad Optical Bandwidth
- Near Gaussian Spectrum
- Low Ripple

Specifications

CW; T (Chip) = 25°C, T (Case) = 0 - 65°C

Parameter		Min	Typ	Max	
Operating Current	I_{OP}		500	650	mA
Center Wavelength	λ_C	1290	1310	1330	nm
ASE Power @ I_{OP}	P_{ASE}	5	7		mW
Optical Bandwidth	BW	60	65		nm
Gain Ripple (rms) @ I_{OP} , Res. BW = 0.1 nm	δG			0.25	dB
Forward Voltage @ I_{OP}	V_F		1.3	2.0	V
Photodiode Sensitivity @ $V_{PD} = -5V$	S_{PD}	0.05	0.1	0.8	A/W
TEC Operation (typ / max @ $T_{CASE} = 25^\circ C / 65^\circ C$)					
- TEC Current	I_{TEC}		0.3	1.5	A
- TEC Voltage	V_{TEC}		0.6	3.5	V
- Thermistor Resistance	R_{TH}		10K		Ω

SPECIFICATIONS ARE SUBJECT TO CHANGE WITHOUT NOTICE

The picture is a representation. The actual part may vary from the one shown.

SLD 1105

Performance

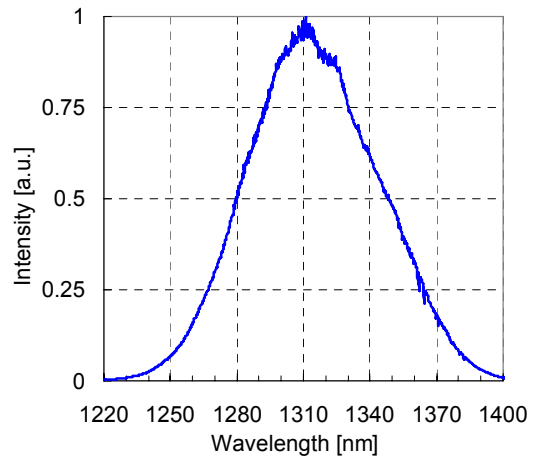
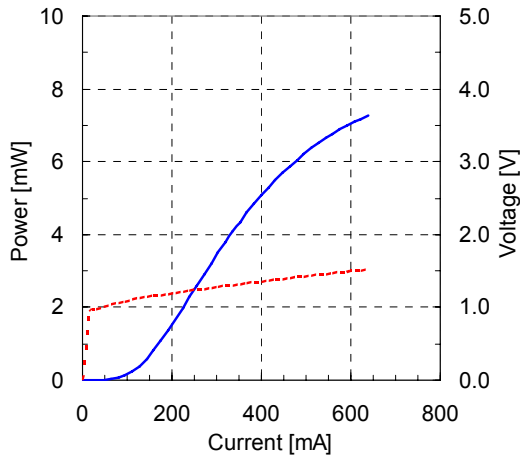

Package drawing

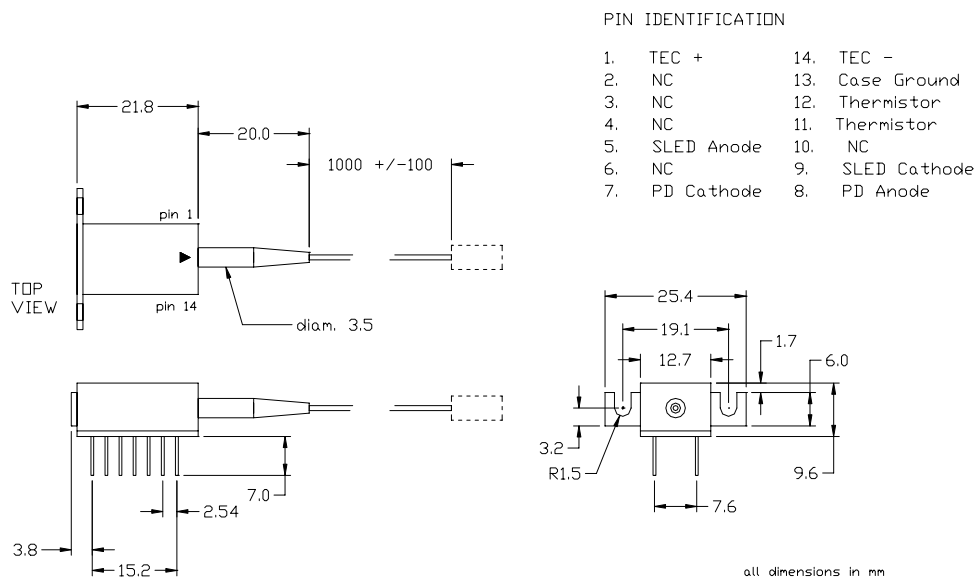

Ordering Information

SLD 1105 - 0 - 2 - C - S - A					
0	2	C	S	A	Numeric
Isolator	Photodiode	Fiber jacket configuration*	Fiber Type	Connector type	Reserved
0 = N/A	2 = included	C = Tight jacket coating	S = SMF	A = FC/APC	1 = Reserved
					2 = Reserved

* see separate fibertail options datasheet

© Covega Corporation - All rights reserved

SLD 1021: 1310nm / 10mW Super Luminescent Diode

7.1.2.SP.1021 Rev D

Description

The SLD 1021 is a 1310 nm high power, broadband Super Luminescent Diode (SLD) with near Gaussian spectral profile and low ripple.

It is housed in a standard 14-pin butterfly package with integrated thermoelectric cooler and thermistor. Packaging options include isolator and choice of single mode fiber or polarization maintaining output fiber tails (see + Packaging drawing for options).

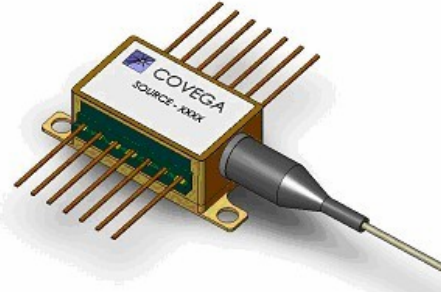

Features

Applications

- ✓ Medical, Optical Coherence Tomography
- ✓ Telecom and Datacom
- ✓ Sensors
- ✓ Fiber Optic Gyros
- ✓ Instrumentation

- High Output Power
- Broad Optical Bandwidth
- Near Gaussian Spectrum
- Low Ripple

Specifications

CW; T (Chip) = 25°C, T (Case) = 0 - 65°C

Parameter		Min	Typ	Max	
Operating Current	I_{OP}		800	900	mA
Center Wavelength	λ_C	1290	1310	1330	nm
ASE Power @ I_{OP}	P_{ASE}	10	15		mW
Optical Bandwidth	BW	60	65		nm
Gain Ripple (rms) @ I_{OP} , Res. BW = 0.1 nm	δG			0.35	dB
Forward Voltage @ I_{OP}	V_F		1.3	2.0	V
TEC Operation (typ / max @ $T_{CASE} = 25^\circ\text{C} / 65^\circ\text{C}$)					
- TEC Current Base model / Option model	I_{TEC}		0.3	1.5	A
- TEC Voltage Base model / Option model	V_{TEC}		0.6	3.5	V
- Thermistor Resistance	R_{TH}		10K		Ω

SPECIFICATIONS ARE SUBJECT TO CHANGE WITHOUT NOTICE

Performance

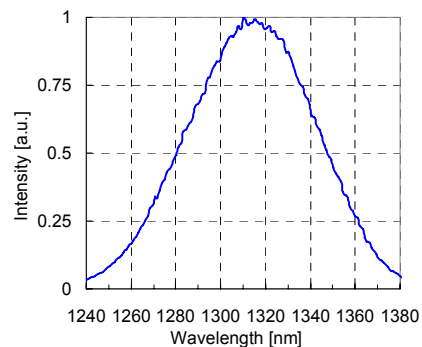
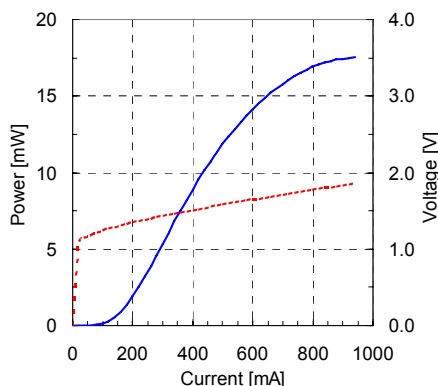

The picture is a representation. The actual part may vary from the one shown.

SLD 1021

Package drawing for base model

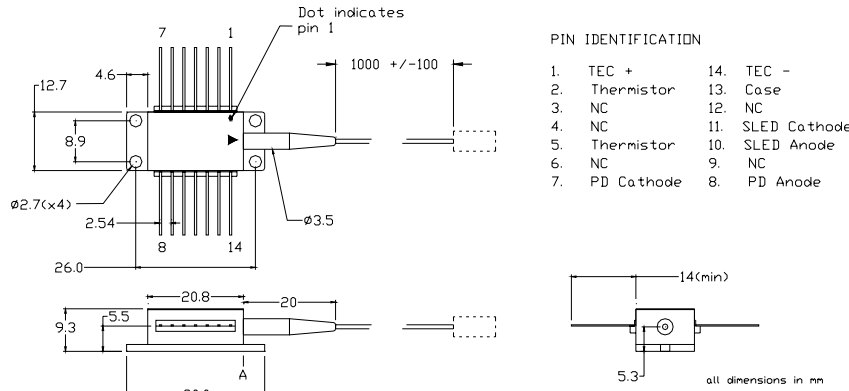

Base model configuration: SLD 1021 - 0 - 2 - C - S - A

+ Package drawing for options model

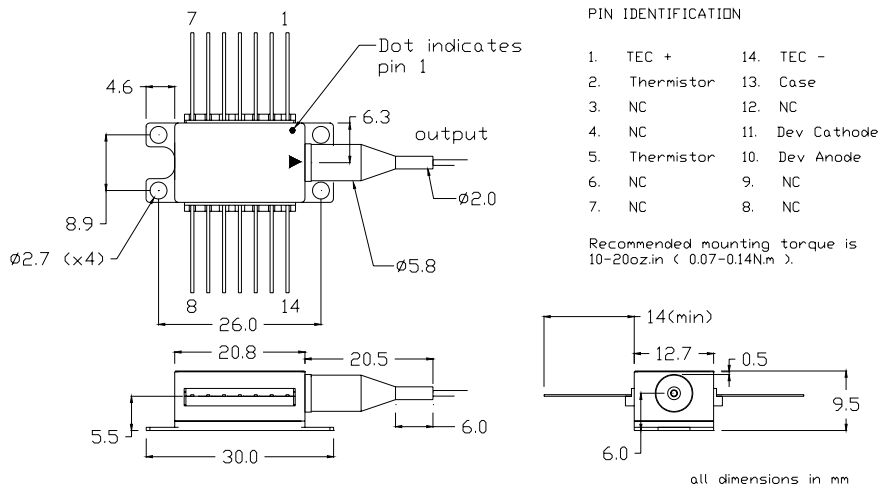

Ordering Information for option model

SLD 1021 - X - 0 - X - X - X					
X	0	X	X	X	Numeric
Isolator	Photodiode	Fiber jacket configuration*	Fiber Type	Connector type	Reserved
0 = none	0 = N/A	U = SMF-8, loose tube	S = SMF	B = Bare Fiber	1 = Reserved
2 = output		T = SMF-28, tight jacket	P = PMF	A = FC/APC	2 = Reserved
		W = PMF 1300 nm, loose tube		O = Other	
		C = reserved			

* see separate fibertail options datasheet

SLD 1024: 1310nm / 15mW Super Luminescent Diode

7.1.2.SP.1024 Rev D

Description

The SLD 1024 is a 1310 nm high power, broadband Super Luminescent Diode (SLD) with near Gaussian spectral profile and low ripple.

It is housed in a standard 14-pin dual in line (DIL) package with integrated thermoelectric cooler, thermistor and Photodiode coupled to a single mode fiber output fiber tail.

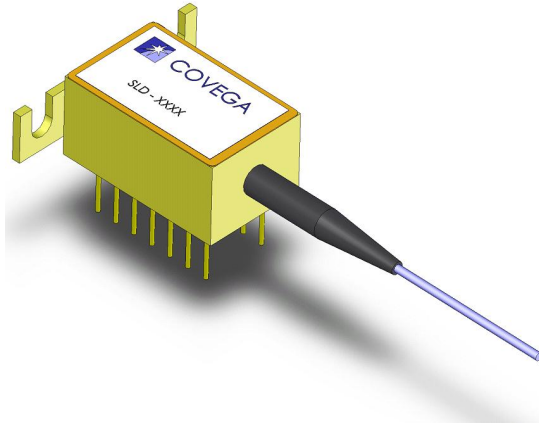

Features

Applications

- ✓ Medical, Optical Coherence Tomography
- ✓ Telecom and Datacom
- ✓ Sensors
- ✓ Fiber Optic Gyros
- ✓ Instrumentation

- High Output Power
- Broad Optical Bandwidth
- Near Gaussian Spectrum
- Low Ripple

Specifications

CW; T (Chip) = 25°C, T (Case) = 0 - 65°C

Parameter		Min	Typ	Max	
Operating Current	I_{OP}		500	650	mA
Center Wavelength	λ_C	1290	1310	1330	nm
ASE Power @ I_{OP}	P_{ASE}	15	22		mW
Optical Bandwidth	BW	35	40		nm
Gain Ripple (rms) @ I_{OP} , Res. BW = 0.1 nm	δG		0.08	0.20	dB
Forward Voltage @ I_{OP}	V_F		1.4	1.6	V
Photodiode Sensitivity @ $V_{PD} = -5V$	S_{PD}	0.05	0.1	0.8	A/W
TEC Operation (typ / max @ $T_{CASE} = 25^\circ C / 65^\circ C$)					
- TEC Current	I_{TEC}		0.35	1.5	A
- TEC Voltage	V_{TEC}		0.65	3.5	V
- Thermistor Resistance	R_{TH}		10K		Ω

SPECIFICATIONS ARE SUBJECT TO CHANGE WITHOUT NOTICE

The picture is a representation. The actual part may vary from the one shown.

SLD 1024

Performance

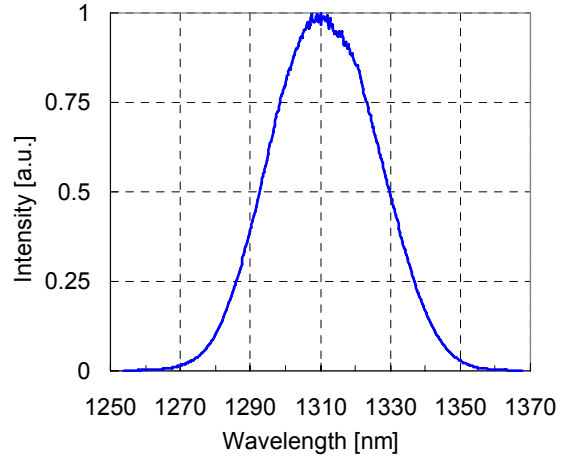
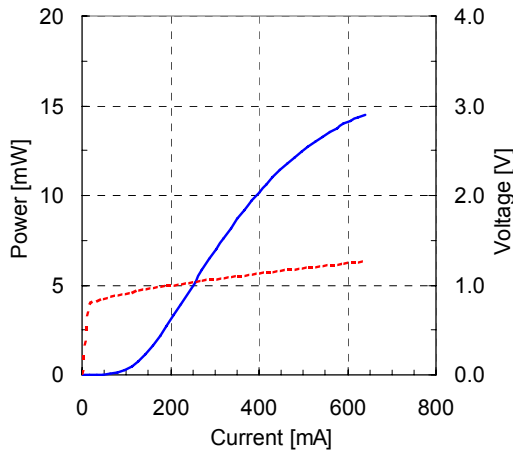

Package drawing

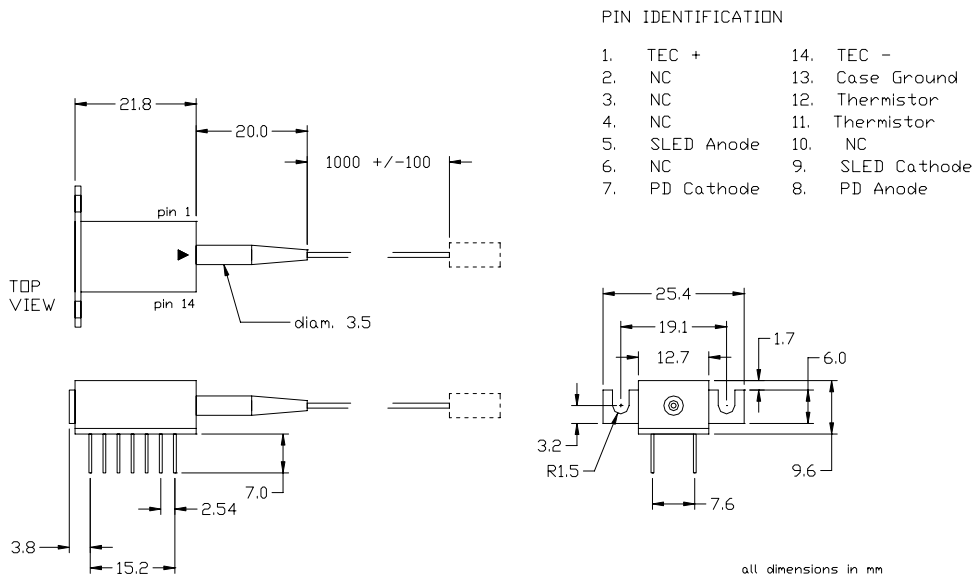

Ordering Information

SLD 1024 - 0 - 2 - C - S - A					
0	2	C	S	A	Numeric
Isolator	Photodiode	Fiber jacket configuration*	Fiber Type	Connector type	Reserved
0 = N/A	2 = included	C = Tight jacket coating	S = SMF	A = FC/APC	1 = Reserved
					2 = Reserved

* see separate fibertail options datasheet

© Covega Corporation - All rights reserved

SLD 1018: 1310nm / 15mW Super Luminescent Diode

7.1.2.SP.1018 Rev D

Description

The SLD 1018 is a 1310 nm high power, broadband Super Luminescent Diode (SLD) with near Gaussian spectral profile and low ripple.

It is housed in a standard 14-pin butterfly package with integrated thermoelectric cooler and thermistor. Packaging options include isolator and choice of single mode fiber and polarization maintaining output fiber tails (see + Packaging drawing for options).

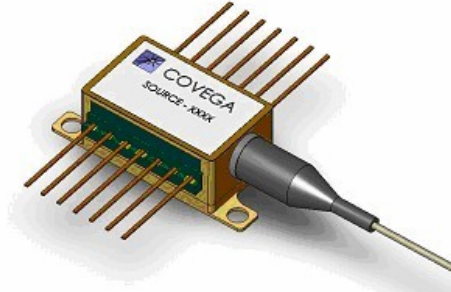

Applications

- ✓ Medical, Optical Coherence Tomography
- ✓ Telecom and Datacom
- ✓ Sensors
- ✓ Fiber Optic Gyros
- ✓ Instrumentation

Features

- High Output Power
- Broad Optical Bandwidth
- Near Gaussian Spectrum
- Low Ripple

Specifications

CW; T (Chip) = 25°C, T (Case) = 0 - 65°C

Parameter		Min	Typ	Max	
Operating Current	I_{OP}		600	800	mA
Center Wavelength	λ_C	1290	1310	1330	nm
ASE Power @ I_{OP}	P_{ASE}	15	20		mW
Optical Bandwidth	BW	45	55		nm
Gain Ripple (rms) @ I_{OP} , Res. BW = 0.1 nm	δG		0.08	0.35	dB
Forward Voltage @ I_{OP}	V_F		1.4	1.6	V
TEC Operation (typ / max @ $T_{CASE} = 25^\circ C / 65^\circ C$)					
- TEC Current Base model / Option model	I_{TEC}		0.3	1.5	A
- TEC Voltage Base model / Option model	V_{TEC}		0.6	3.5	V
- Thermistor Resistance	R_{TH}		10K		Ω

SPECIFICATIONS ARE SUBJECT TO CHANGE WITHOUT NOTICE

Performance

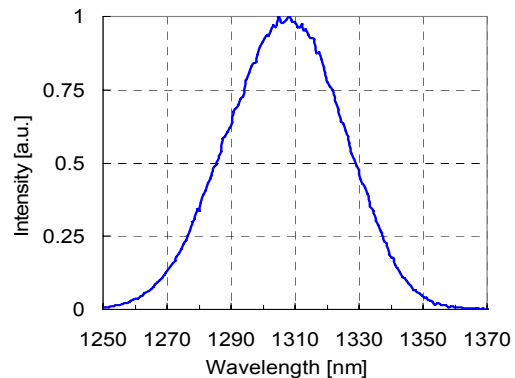
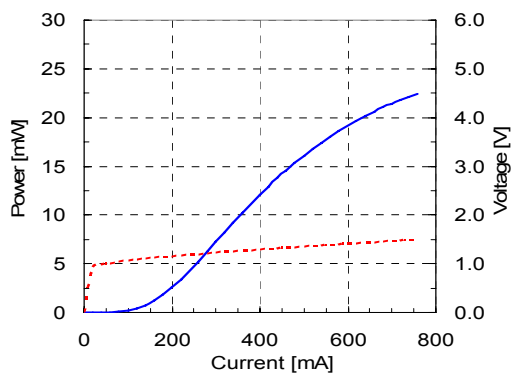

The picture is a representation. The actual part may vary from the one shown.

SLD 1018

Package drawing for base model

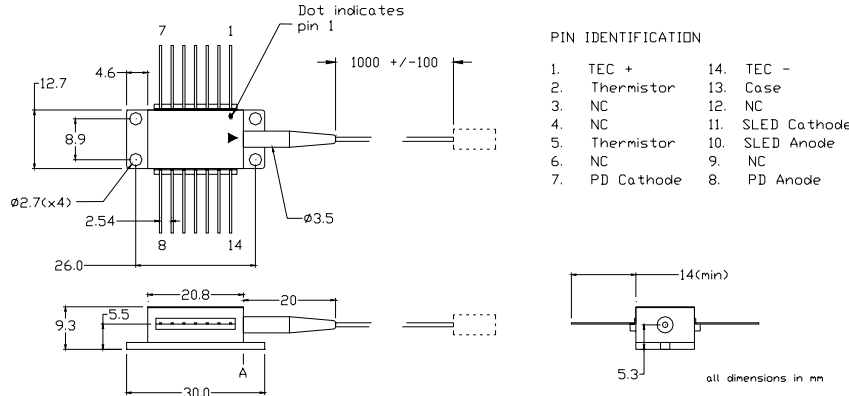

Base model configuration: SLD 1018 - 0 - 2 - C - S - A

+ Package drawing for options model

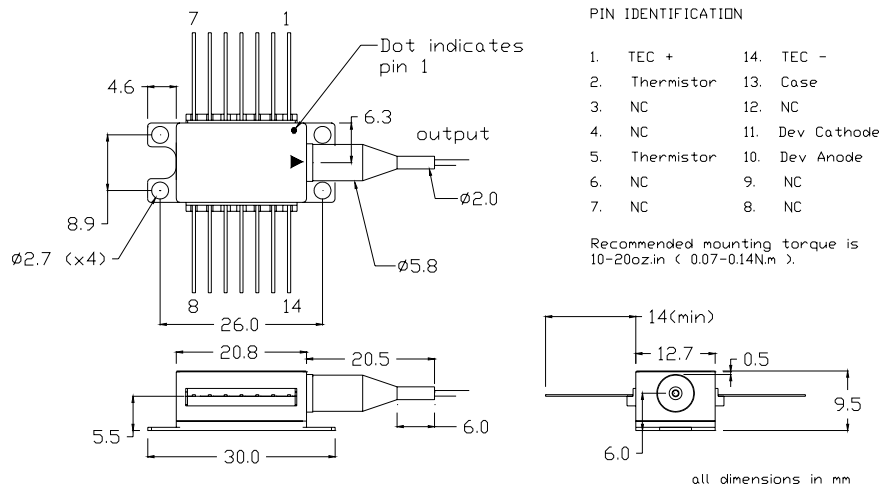

Ordering Information

SLD 1018 - X - 0 - X - X - X					
X	0	X	X	X	Numeric
Isolator	Photodiode	Fiber jacket configuration*	Fiber Type	Connector type	Reserved
0 = none	0 = N/A	U = SMF-8, loose tube	S = SMF	B = Bare Fiber	1 = Reserved
2 = output		T = SMF-28, tight jacket	P = PMF	A = FC/APC	2 = Reserved
		W = PMF 1300 nm, loose tube		O = Other	
		C = reserved			

* see separate fibertail options datasheet

© Covega Corporation - All rights reserved

SLD 1128: 1550nm / 1mW Super Luminescent Diode

7.1.2.SP.1128 Rev B

Engineering Model

Description

The SLD 1128 is a 1550 nm low power, broadband Super Luminescent Diode (SLD) with near Gaussian spectral profile and low ripple.

It is housed in a standard 14-pin dual in line (DIL) package with integrated thermoelectric cooler, thermistor and Photodiode coupled to a single mode fiber output fiber tail.

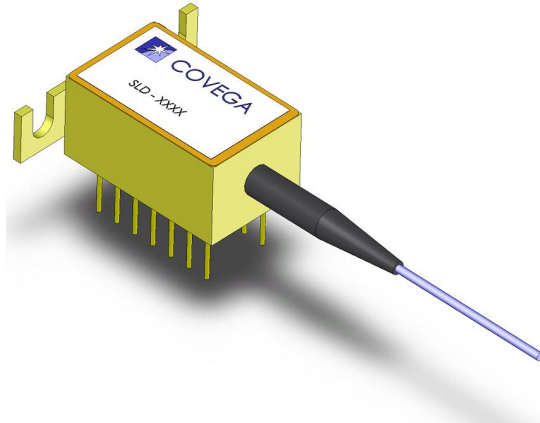

Features

Applications

- ✓ Telecom and Datacom
- ✓ Sensors
- ✓ Fiber Optic Gyros
- ✓ Instrumentation

- Low Output Power
- Broad Optical Bandwidth
- Near Gaussian Spectrum
- Low Ripple

Specifications

CW; T (Chip) = 25°C, T (Case) = 0 - 65°C

Parameter		Min	Typ	Max	
Operating Current	I_{OP}		400	500	mA
Center Wavelength	λ_C	1520	1550	1580	nm
ASE Power @ I_{OP}	P_{ASE}	0.75	1.0		mW
Optical Bandwidth	BW	100	110		nm
Gain Ripple (rms) @ I_{OP} , Res. BW = 0.1 nm	δG			0.1	dB
Forward Voltage @ I_{OP}	V_F		1.6	2.0	V
Photodiode Sensitivity @ $V_{PD} = -5V$	S_{PD}	0.05	0.1	0.8	A/W
TEC Operation (typ / max @ $T_{CASE} = 25^\circ C / 65^\circ C$)					
- TEC Current	I_{TEC}		0.35	1.5	A
- TEC Voltage	V_{TEC}		0.5	3.5	V
- Thermistor Resistance	R_{TH}		10K		Ω
SPECIFICATIONS ARE SUBJECT TO CHANGE WITHOUT NOTICE					

The picture is a representation. The actual part may vary from the one shown.

SLD 1128

Performance

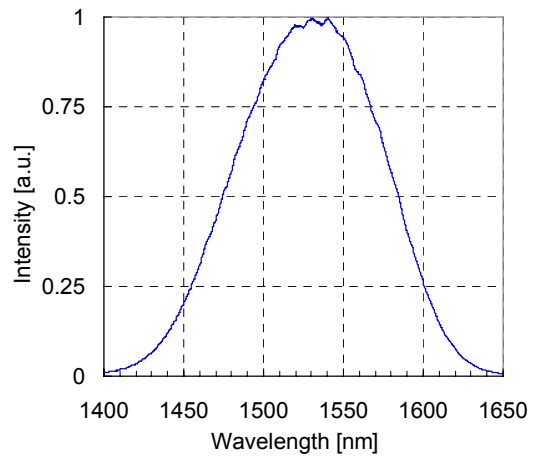
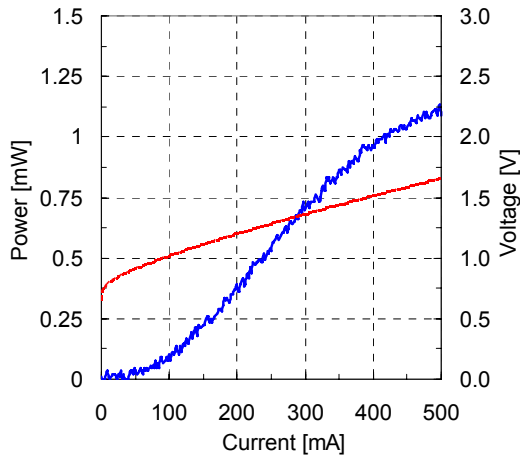

Package drawing

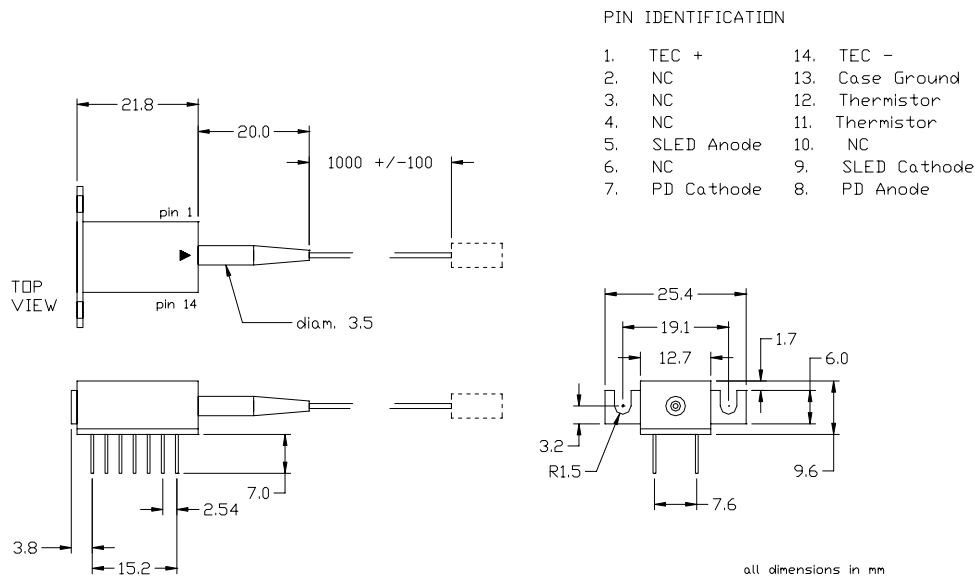

Ordering Information

SLD 1128 - 0 - 2 - C - S - A					
0	2	C	S	A	Numeric
Isolator	Photodiode	Fiber jacket configuration*	Fiber Type	Connector type	Reserved
0 = N/A	2 = included	C = Tight jacket coating	S = SMF	A = FC/APC	1 = Reserved
					2 = Reserved

* see separate fibertail options datasheet

© Covega Corporation - All rights reserved

SLD 1108: 1550nm / 2mW Super Luminescent Diode

7.1.2.SP.1108 Rev B Engineering Model

Description

The SLD 1108 is a 1550 nm low power, broadband Super Luminescent Diode (SLD) with near Gaussian spectral profile and low ripple.

It is housed in a standard 14-pin dual in line (DIL) package with integrated thermoelectric cooler, thermistor and Photodiode coupled to a single mode fiber output fiber tail.

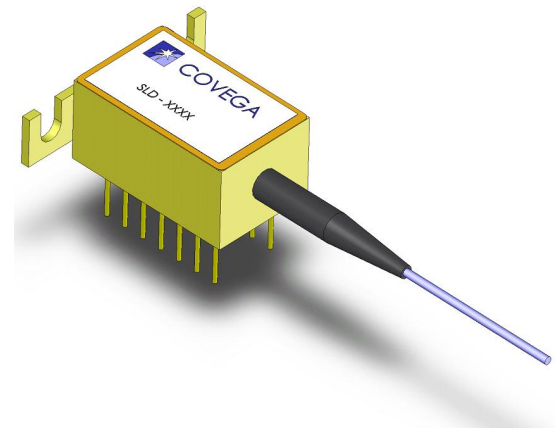

Applications

- ✓ Telecom and Datacom
- ✓ Sensors
- ✓ Fiber Optic Gyros
- ✓ Instrumentation

Features

- Low Output Power
- Broad Optical Bandwidth
- Near Gaussian Spectrum
- Low Ripple

Specifications

CW; T (Chip) = 25°C, T (Case) = 0 - 65°C

Parameter		Min	Typ	Max	
Operating Current	I_{OP}		450	550	mA
Center Wavelength	λ_C	1530	1550	1570	nm
ASE Power @ I_{OP}	P_{ASE}	2	2.5		mW
Optical Bandwidth	BW	85	90		nm
Gain Ripple (rms) @ I_{OP} , Res. BW = 0.1 nm	δG			0.25	dB
Forward Voltage @ I_{OP}	V_F		1.6	2.0	V
Photodiode Sensitivity @ $V_{PD} = -5V$	S_{PD}	0.05	0.1	0.8	A/W
TEC Operation (typ / max @ $T_{CASE} = 25^\circ C / 65^\circ C$)					
- TEC Current	I_{TEC}		0.3	1.5	A
- TEC Voltage	V_{TEC}		0.5	3.5	V
- Thermistor Resistance	R_{TH}		10K		Ω

SPECIFICATIONS ARE SUBJECT TO CHANGE WITHOUT NOTICE

The picture is a representation. The actual part may vary from the one shown.

SLD 1108

Performance

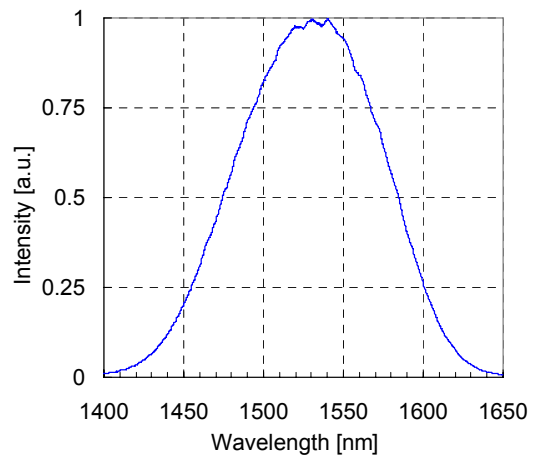
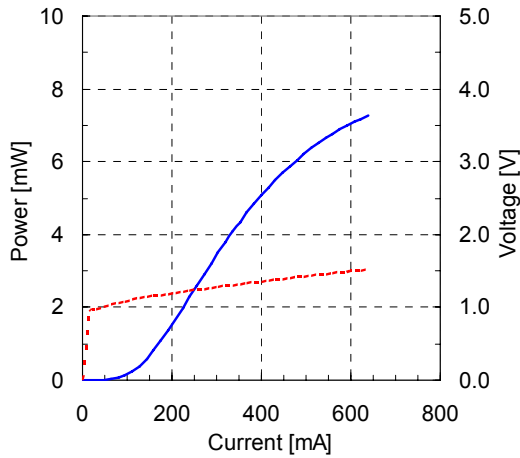

Package drawing

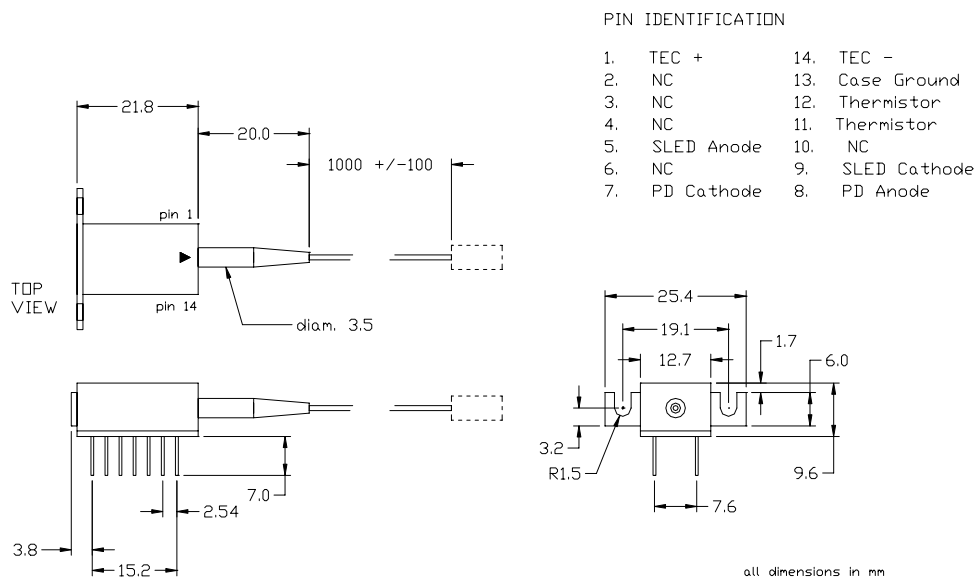

PIN IDENTIFICATION

- | | |
|---------------|-----------------|
| 1. TEC + | 14. TEC - |
| 2. NC | 13. Case Ground |
| 3. NC | 12. Thermistor |
| 4. NC | 11. Thermistor |
| 5. SLED Anode | 10. NC |
| 6. NC | 9. SLED Cathode |
| 7. PD Cathode | 8. PD Anode |

Ordering Information

SLD 1108 - 0 - 2 - C - S - A					
0	2	C	S	A	Numeric
Isolator	Photodiode	Fiber jacket configuration*	Fiber Type	Connector type	Reserved
0 = N/A	2 = included	C = Tight jacket coating	S = SMF	A = FC/APC	1 = Reserved
					2 = Reserved

* see separate fibertail options datasheet

© Covega Corporation - All rights reserved

SLD 1030: 1550nm / 10mW Super Luminescent Diode

7.1.2.SP.1030 Rev C

Description

The SLD 1030 is a 1550 nm high power, broadband Super Luminescent Diode (SLD) with near Gaussian spectral profile and low ripple.

It is housed in a standard 14-pin dual in line (DIL) package with integrated thermoelectric cooler, thermistor and Photodiode coupled to a single mode fiber output fiber tail.

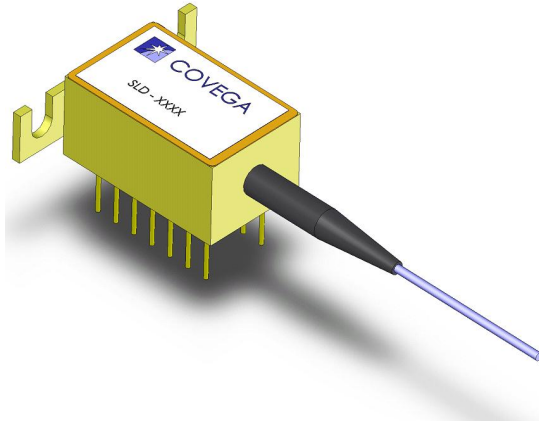

Features

Applications

- ✓ Medical, Optical Coherence Tomography
- ✓ Telecom and Datacom
- ✓ Sensors
- ✓ Fiber Optic Gyros
- ✓ Instrumentation

- High Output Power
- Broad Optical Bandwidth
- Near Gaussian Spectrum
- Low Ripple

Specifications

CW; T (Chip) = 25°C, T (Case) = 0 - 65°C

Parameter		Min	Typ	Max	
Operating Current	I_{OP}		500	650	mA
Center Wavelength	λ_C	1530	1550	1570	nm
ASE Power @ I_{OP}	P_{ASE}	13	16		mW
Optical Bandwidth	BW	40	45		nm
Gain Ripple (rms) @ I_{OP} , Res. BW = 0.1 nm	δG		0.2	0.30	dB
Forward Voltage @ I_{OP}	V_F		1.3	1.6	V
Photodiode Sensitivity @ $V_{PD} = -5V$	S_{PD}	0.05	0.1	0.8	A/W
TEC Operation (typ / max @ $T_{CASE} = 25^\circ C / 65^\circ C$)					
- TEC Current	I_{TEC}		0.3	1.5	A
- TEC Voltage	V_{TEC}		0.6	3.5	V
- Thermistor Resistance	R_{TH}		10K		Ω

SPECIFICATIONS ARE SUBJECT TO CHANGE WITHOUT NOTICE

The picture is a representation. The actual part may vary from the one shown.

SLD 1030

Performance

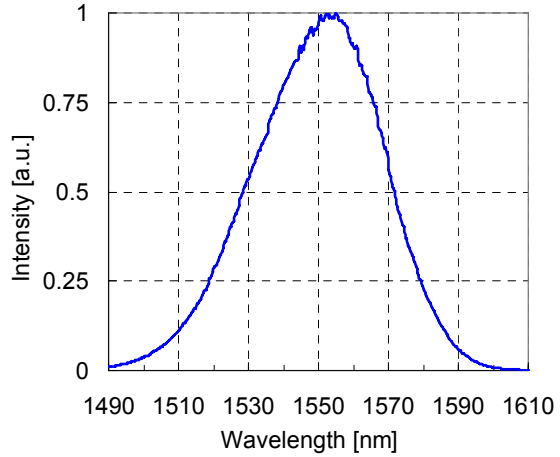
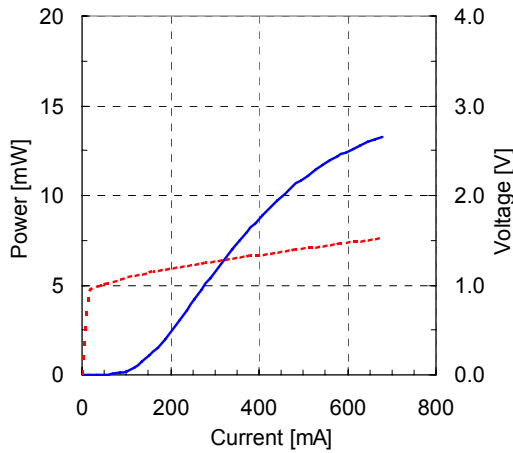

+ Package drawing

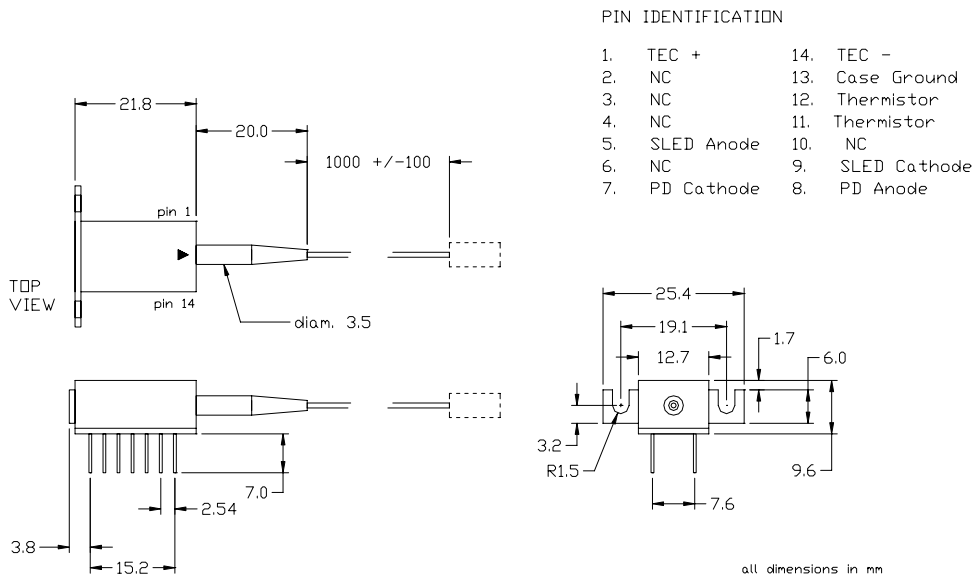

Ordering Information

SLD 1030 - 0 - 2 - C - S - A					
0	0	X	S	X	Numeric
Isolator	Photodiode	Fiber jacket configuration*	Fiber Type	Connector type	Reserved
0 = N/A	2 = included	C = Tight jacket coating	S = SMF	A = FC/APC	1 = Reserved
					2 = Reserved
* see separate fibertail options datasheet					

© Covega Corporation - All rights reserved

SLD 1005: 1550nm / 15mW Super Luminescent Diode

7.1.2.SP.1005 Rev D

Description

The SLD 1005 is a 1550 nm high power, broadband Super Luminescent Diode (SLD) with near Gaussian spectral profile and low ripple.

It is housed in a standard 14-pin butterfly package with integrated thermoelectric cooler and thermistor. Packaging options include isolator and choice of single mode fiber and polarization maintaining output fiber tails (see + Packaging drawing for options).

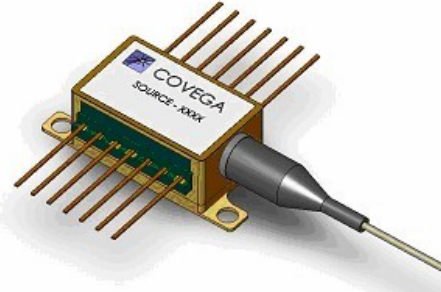

Features

Applications

- ✓ Medical, Optical Coherence Tomography
- ✓ Telecom and Datacom
- ✓ Sensors
- ✓ Fiber Optic Gyros
- ✓ Instrumentation

- High Output Power
- Broad Optical Bandwidth
- Near Gaussian Spectrum
- Low Ripple

Specifications

CW; T (Chip) = 25°C, T (Case) = 0 - 65°C

Parameter		Min	Typ	Max	
Operating Current	I_{OP}		600	800	mA
Center Wavelength	λ_C	1530	1550	1570	nm
ASE Power @ I_{OP}	P_{ASE}	15	20		mW
Optical Bandwidth	BW	40	50		nm
Gain Ripple (rms) @ I_{OP} , Res. BW = 0.1 nm	δG		0.18	0.35	dB
Forward Voltage @ I_{OP}	V_F		1.4	1.6	V
TEC Operation (typ / max @ $T_{CASE} = 25^\circ\text{C} / 65^\circ\text{C}$)					
- TEC Current	I_{TEC}		0.35	1.5	A
- TEC Voltage	V_{TEC}		0.5	3.5	V
- Thermistor Resistance	R_{TH}		10K		Ω

SPECIFICATIONS ARE SUBJECT TO CHANGE WITHOUT NOTICE

Performance

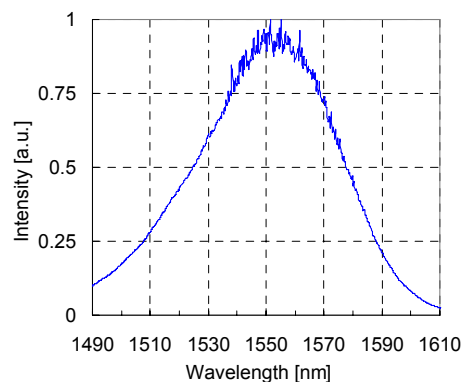
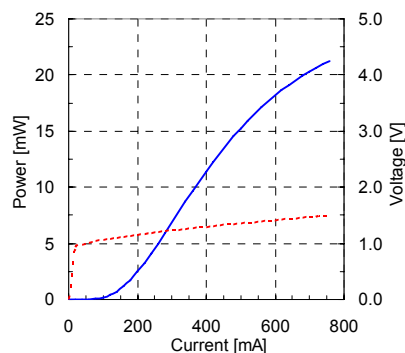

The picture is a representation. The actual part may vary from the one shown.

SLD 1005

Package drawing for base model

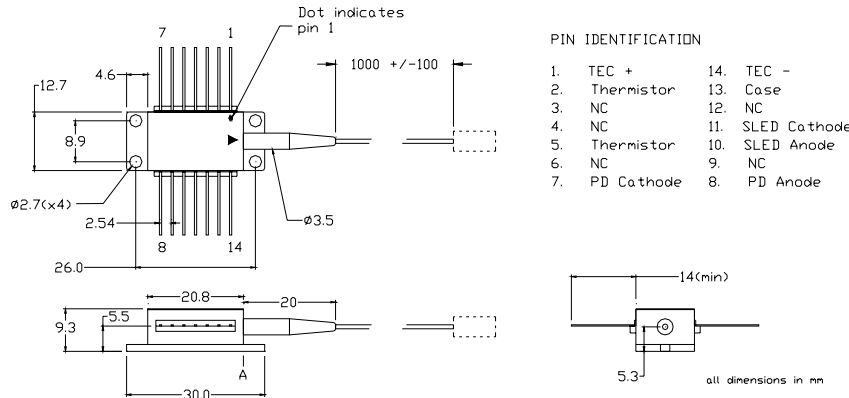

Base model configuration: SLD 1005 - 0 - 2 - C - S - A

+ Package drawing for options model

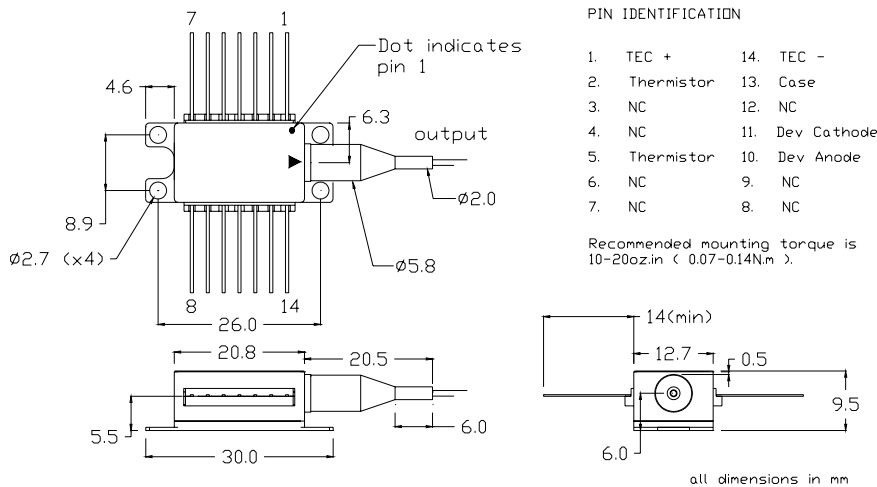

Ordering Information

SLD 1005 - X - 0 - X - X - X

X	0	X	X	X	Numeric
Isolator	Photodiode	Fiber jacket configuration*	Fiber Type	Connector type	Reserved
0 = none	0 = N/A	U = SMF-28, loose tube	S = SMF	B = Bare Fiber	
2 = output		T = SMF-28, tight jacket	P = PMF	A = FC/APC	1 = Reserved
		V = PMF 1550 nm, loose tube		O = Other	2 = Reserved
		C = reserved			

* see separate fibertail options datasheet

© Covega Corporation - All rights reserved



Covega Corporation
10335 Guilford Road, Jessup, MD 20794, USA
Phone: +1 877.226.8342 **Fax:** +1 240.456.7200
Email: sales@covega.com **Web:** <http://www.covega.com>



Covega Corporation
10335 Guilford Road, Jessup, MD 20794, USA
Phone: +1 877.226.8342 **Fax:** +1 240.456.7200
Email: sales@covega.com **Web:** <http://www.covega.com>

Miscellaneous

LDC 1300: Laser Diode Controller - for FPL, BOA, SOA and SLD in Butterfly & DIL Packages

7.1.2.SP.1300 Rev E

Description

COVEGA's Laser Diode Controller (LDC) combines Laser driver, TEC controller and mount in a rugged, compact and cost effective package. The unit is easily controlled by personal computer through a RS-232 interface.

It is suited for evaluation and testing of Covega's Lasers, Superluminescent Diodes and Optical Amplifier products in the laboratory or on the production floor.

The LDC is available for Butterfly and DIL packages and offers highly efficient heat-sinking by means of a solid aluminum mount.

The unit comes with an external 5V wall - plug power supply for rated from 90 - 250V, driver software & manual, RS-232 cable and power cord.

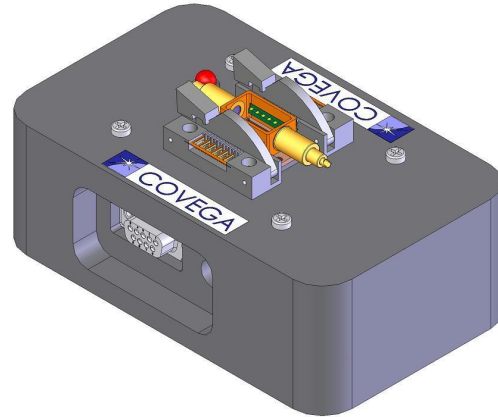

Features

Applications

- ✓ Laboratory Evaluation & Testing of SOAs, BOAs, SLDs, FPLs
- ✓ Inspection of SOAs, BOAs, SLDs, FPLs for production

→ Laser Diode Driver Integrated with TEC Controller

Specifications

CW; T (Chip) = 25°C, T (Case) = 0 - 70°C

Parameter		Min	Typ	Max	
Electrical					
Supply Current	I			2.4	A
Supply Voltage	V	4.5	5	5.5	V
Drive Current	I _D			1000	mA
Drive Current Resolution			16		bit
TEC Set Point	T	10		40	C
TEC Step			0.1		C
Update Rate			3		Hz
Computer Communications					
Compatibility	Windows 95 / 98 / NT / 2000 / XP				
Interface	RS - 232				
SPECIFICATIONS ARE SUBJECT TO CHANGE WITHOUT NOTICE					

The picture is a representation. The actual part may vary from the one shown.

LDC 1300

Drawings

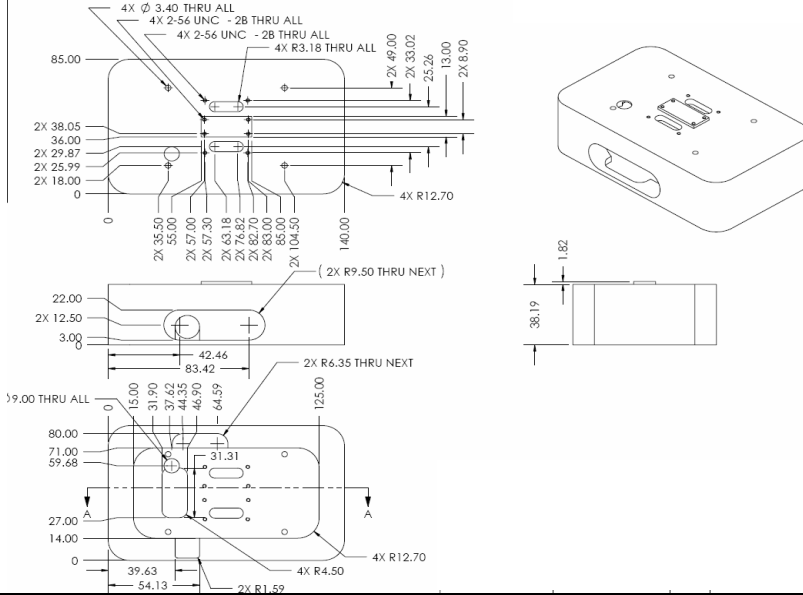

For Butterfly packages

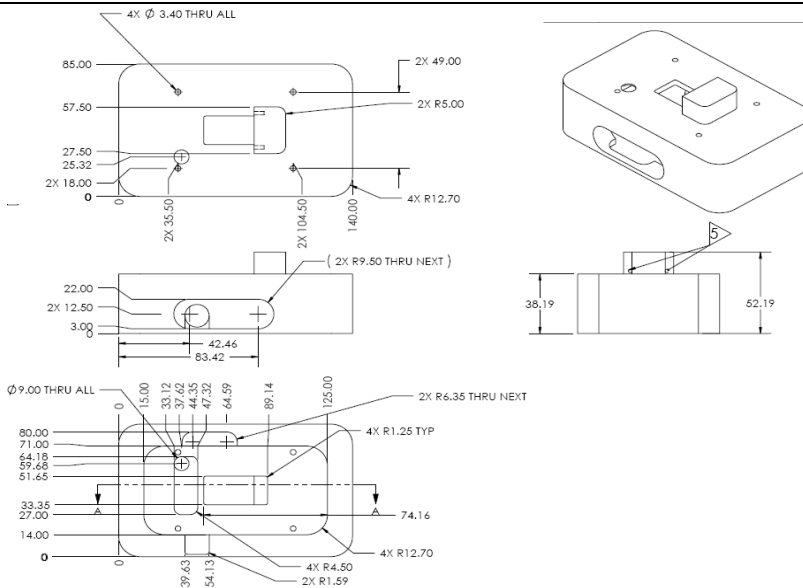

For DIL Packages

Ordering Information

LDC 1300 - XXX

XXX

Package

BFL = Butterfly

DIL = DIL

Fibertail Options for InP Products

Options - Butterfly Package

Six different fibertail options are available for COVEGA's butterfly packages, described in the schematics below:

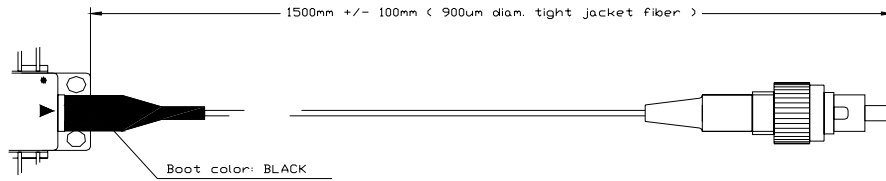

OPTION T : SMF 28: tight jacket / FC/APC

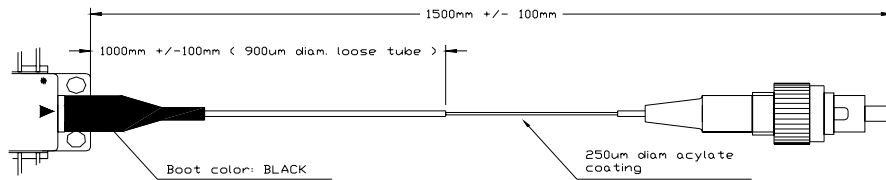

OPTION U : SMF 28: Loose tube / FC/APC

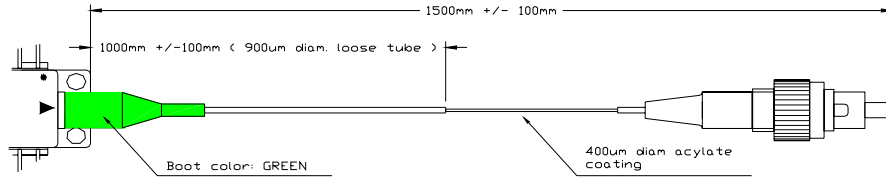

OPTION V : PMF 1550: Loose Tube / FC/APC

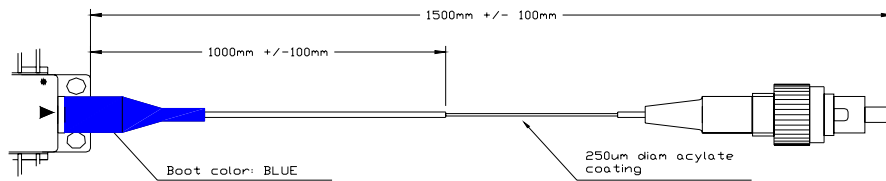

OPTION W : PMF 1300: Loose Tube / FC/APC

Fibertail Options for InP Products

Options – Butterfly Package (Cont.)

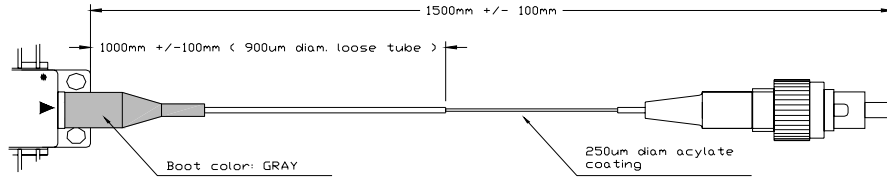

OPTION X : Flexcore 1060: Loose Tube / FC/APC

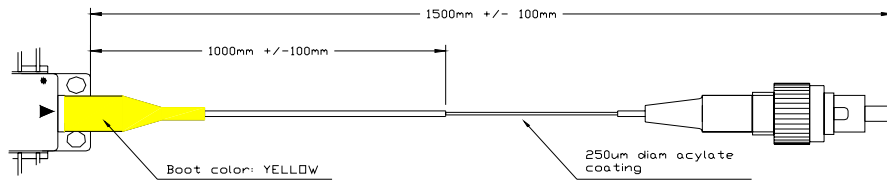

OPTION Y : PMF 980: Loose Tube / FC/APC

Options – DIL Package

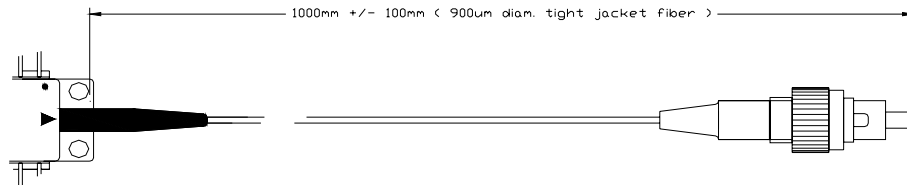

OPTION C :



Covega Corporation
10335 Guilford Road, Jessup, MD 20794, USA
Phone: +1 877.226.8342 **Fax:** +1 240.456.7200
Email: sales@covega.com **Web:** <http://www.covega.com>



Covega Corporation
10335 Guilford Road, Jessup, MD 20794, USA
Phone: +1 877.226.8342 **Fax:** +1 240.456.7200
Email: sales@covega.com **Web:** <http://www.covega.com>

Legal

Covega Corporation Terms & Conditions for the Sale of Covega Products & Services

THE FOLLOWING TERMS AND CONDITIONS CONSTITUTE THE SOLE TERMS AND CONDITIONS UPON WHICH SELLER AGREES TO SELL THE PRODUCTS AND PROVIDE THE SERVICES ORDERED PURSUANT TO THIS AGREEMENT AND SHALL BECOME THE EXCLUSIVE AND BINDING AGREEMENT BETWEEN THE PARTIES COVERING SUCH PRODUCTS AND SERVICES. ANY ACCEPTANCE OF THIS OFFER IS LIMITED TO ACCEPTANCE OF THE EXPRESS TERMS OF THE OFFER CONTAINED IN THIS DOCUMENT. ANY PROPOSAL FOR ADDITIONAL OR DIFFERENT TERMS OR ANY ATTEMPT BY BUYER TO VARY IN ANY DEGREE ANY OF THE TERMS OF THIS OFFER IN BUYER'S ACCEPTANCE SHALL BE DEEMED MATERIAL AND IS HEREBY OBJECTED TO AND REJECTED. SUCH PROPOSAL SHALL NOT OPERATE AS A REJECTION OF THIS OFFER UNLESS VARIANCES ARE IN THE TERMS OF THE DESCRIPTION, QUANTITY, PRICE, OR DELIVERY OR PERFORMANCE SCHEDULE OF THE PRODUCTS OR SERVICES BUT SHALL BE DEEMED A MATERIAL ALTERATION HEREOF, AND THIS OFFER SHALL BE DEEMED ACCEPTED BY BUYER WITHOUT SAID ADDITIONAL OR DIFFERENT TERMS. ANY ADDITIONAL OR DIFFERENT TERMS WHICH MAY BE CONTAINED IN ANY DOCUMENTS FURNISHED BY BUYER ARE HEREBY OBJECTED TO AND REJECTED.

1. PRICE

1.1 Prices for products are F.O.B. Jessup, Maryland, unless otherwise specifically provided. List prices do not include any sales, use, or other taxes, and such taxes shall be paid by Buyer, or in lieu, Buyer shall provide a valid exemption certificate acceptable to taxing authorities. Quoted prices are valid for thirty (30) days from the date of quotation.

2. ITEMS INCLUDED

2.1 Each sale includes only the products and/or services described in the order and does not include any other product or service, unless specifically provided in COVEGA's quotation.

3. PAYMENT TERMS AND CREDIT

3.1 Upon shipment and/or completion of the services, COVEGA shall generate an invoice for the products shipped or services provided. Payment terms are net thirty (30) days from the date of invoice.

3.2 Buyer acknowledges that Seller's credit department may, in its sole discretion, impose more stringent payment requirements, including requiring payment in advance. Should Buyer become delinquent in payment of any sum due hereunder, Seller shall not be obligated to continue performance under this agreement. Seller reserves the right to charge interest, at the maximum legal rate, on all delinquent accounts.

4. SECURITY INTEREST

4.1 If Buyer fails to pay the total sum due hereunder within sixty (60) days of shipment, Seller hereby reserves and Buyer hereby grants a purchase money security interest in the products sold hereunder and the proceeds thereof. In the event of default by Buyer of any of its obligations to Seller, Seller shall have the right to repossess the products sold hereunder with liability to Buyer. Upon request of Seller, Buyer agrees to promptly execute financing statements and such other instruments as Seller desires to perfect or maintain its security interest.

5. SHIPMENT/ PERFORMANCE SCHEDULES

5.1 Shipment of products and performance of services shall be scheduled as mutually agreed upon between Buyer and Seller. Seller shall make reasonable efforts to meet any shipment or performance date(s) quoted or acknowledged; however, Seller shall not be liable for any failure to meet such date(s) unless Seller has agreed in writing to accept a penalty clause. Shipment commences upon receipt of hard copy purchase order only.

5.2 Rescheduling. Buyer may reschedule an order for products or services only upon the written consent of Seller. Any such rescheduling must be for delivery of products or performance of services within three (3) months of the originally scheduled delivery or performance date, and Buyer shall be required to pay a progress payment for materials and labor in progress.

6. SHIPMENT, PACKING AND RISK OF LOSS

6.1 Point of Delivery and Shipping Charges. Delivery shall be made F.O.B. Seller's plant. Buyer shall pay all shipping and insurance charges incurred from the delivery point (including transportation, routing, rigging and accessorial charges). In the event of foreign sales, Buyer shall pay all shipping charges incurred from Seller's dock to Buyer's dock including charges for customs clearance site.

6.2 Method of Shipment. Unless otherwise agreed in writing, Seller shall prepay freight charges for Buyer and add such charges to Seller's invoice. Seller shall ship in accordance with its standard shipping practices.

6.3 Packing. Unless otherwise agreed in writing, all products shall be packed, if appropriate, for shipment and storage in accordance with standard commercial practices. All packing shall conform to requirements of the carrier's tariffs. Any request from Buyer to package products differently may subject Buyer to an additional charge.

6.4 Risk of Loss. Title to the products and risk of loss or damage shall pass to Buyer upon shipment via designated common carrier, F.O.B. Seller's plant.

7. INSTALLATION/PERFORMANCE OF SERVICES

7.1 Installation of the products is the responsibility of the Buyer, unless otherwise agreed. Seller is not responsible for any loss or damage arising out of any work performed on Buyer's premises, unless the loss or damage is proximately caused by Seller's negligence.

7.2 Acceptance. Acceptance shall be deemed to occur at the time the product or item services satisfactorily performs and complies with COVEGA's standard acceptance criteria or alternate acceptance criteria mutually agreed to in writing, or within forty-five (45) days after shipment or completion of the services, whichever is earlier. Any productive use of the system(s) by the customer shall be deemed as an acceptance of the system by the customer.

8. CANCELLATION CHARGES

8.1 In the event Buyer should cancel an order for products, cancellation charges (if not otherwise delineated in Seller's quotation to Buyer) shall be paid to Seller based upon a percentage of the price for the cancelled products, and the relation of the date of cancellation to the order date as follows:

<u>Cancellation Date</u>	<u>Cancellation Charge</u>
0-40 days prior to scheduled shipment date.	80% of contract price
41-90 days prior to scheduled shipment date.	50% of contract price
91 or more days prior to scheduled shipment date.	30% of contract price

Buyer acknowledges and agrees that these charges are necessary and appropriate to compensate Seller for its expenses incurred prior to Buyer's cancellation of an order, in whole or in part, and are reasonable in view of the circumstances existing at the time this transaction is entered into. Buyer agrees to pay all invoices for cancellation charges within 30 days.

9. WARRANTY AGAINST INFRINGEMENT; INDEMNIFICATION BY BUYER

9.1 Seller warrants that the products sold hereunder shall be delivered free of the rightful claim of any third person by way of infringement or the like; provided, however, that if Buyer furnishes specifications to Seller, then Buyer must hold Seller harmless and indemnify Seller against any infringement or other claim involving alleged violation of intellectual property rights arising out of compliance with Buyer's specifications. Seller's warranty against infringement shall not apply to any claim based upon (a) any alteration of Seller's product by any person other than Seller or (b) use of Seller's product on or in conjunction with any equipment or item not supplied by Seller for use with the product or (c) use of the products in connection with any process. Buyer's indemnification obligations shall survive the termination of this agreement.

10. PROPRIETARY INFORMATION AND TECHNOLOGY RIGHTS

10.1 Proprietary Information - Confidentiality. Any documentation, data, or information of any kind supplied by Seller to Buyer shall be deemed proprietary to Seller and treated as confidential by Buyer. Seller retains for itself all proprietary rights in and to all Confidential Information. Buyer shall not disclose, without Seller's written consent, any Confidential Information to any other person, or use Confidential Information for any purpose other than performing under this agreement. Buyer shall return all Confidential Information, together with all copies thereof, to Seller at Seller's request. The obligations under this paragraph shall survive the cancellation, termination or completion of this agreement. Seller may, at its sole option, require Buyer to execute a separate confidentiality agreement acceptable to Seller as a condition to providing any documentation or data which it considers proprietary or confidential.

10.2 Technology Rights. All products, information and technology produced, conceived or otherwise developed by or for Seller, or as a result of technology furnished by Seller, shall be the sole property of Seller, and Buyer shall have no ownership or other rights in such property. Buyer agrees to use such products, information and technology only in connection with products or services furnished by Seller and otherwise to retain them as confidential in accordance with Section 10.1 above. Buyer, at its cost, hereby assigns to Seller all right, title and interest in all inventions, trade secrets, patents, mask works, copyrights, trademarks and other intellectual property developed by or for Seller in connection with the conception, design, development or manufacture of products or services and shall fully cooperate with and assist Seller in perfecting such rights.

11. SALE CONVEYS NO LICENSE

11.1 The sale of products or services hereunder by Seller does not convey any license under any patent, copyright, trade secret or other proprietary right with respect to which Seller can grant licenses. Seller expressly reserves all of its rights with respect to such patent, copyright, trade secret and/or other proprietary rights.

12. MODIFICATIONS AND CHANGES

12.1 If Buyer makes changes in the specifications applicable to products ordered hereunder and if Seller agrees to make such changes, Buyer shall be responsible for Seller's additional costs in complying with such changes.

13. LIMITED WARRANTY AND DISCLAIMER; REMEDY

13.1 Warranty and Warranty Period. Seller warrants that all products provided hereunder shall be free from defects in material and workmanship under normal use and service, and all services shall be performed in a good and workmanlike manner. This warranty is subject to the following conditions: (a) misuse, unauthorized repair, inadequate or improper maintenance, alteration of product, or similar inappropriate conduct by Buyer shall absolve Seller from any liability; and (b) Buyer must notify Seller of any claim for breach of warranty within ten (10) days after the claim arises. This warranty does not extend to any defect which arises as a result of causes external to the product (such as power or air conditioning failure) which are not covered by warranty or which arise out of the installation or use of parts not authorized by Seller. Except as otherwise agreed by Seller in writing, this warranty does not extend to any custom products which have been produced to Buyer's specifications. Unless a specific warranty period is delineated in Attachment A hereto, the foregoing warranty shall extend for a period of one year from the date of delivery of any product.

13.2 DISCLAIMER. THE IMPLIED WARRANTIES OF MERCHANTABILITY AND FITNESS FOR A PARTICULAR PURPOSE AND ALL OTHER WARRANTIES, EXPRESS OR IMPLIED, EXCEPT FOR ANY WARRANTIES SET FORTH IN THIS DOCUMENT, ARE EXCLUDED FROM THIS TRANSACTION AND SHALL NOT APPLY TO THE PRODUCTS OR SERVICES SOLD.

13.3 Remedy. Buyer's exclusive remedy against Seller shall be for Seller to use its best efforts to repair or replace any defective products or remedy any unacceptable services. Any such repair, replacement or remedy shall be at no charge to Buyer. If Seller is unable to repair or replace a defective product, or remedy an unacceptable service then Buyer's sole remedy shall be the return of the purchase price for that product or service. No other remedies (including, but not limited to, incidental or consequential damages for lost profits, lost sales, injury to person or property, or any other incidental or consequential loss) shall be available to Buyer.

14. EXCLUSION OF CONSEQUENTIAL DAMAGES; LIMITATION OF LIABILITY

14.1 EXCLUSION OF CONSEQUENTIAL DAMAGES. NOTWITHSTANDING ANYTHING TO THE CONTRARY CONTAINED HEREIN, SELLER SHALL NOT, UNDER ANY CIRCUMSTANCES, BE LIABLE TO BUYER FOR CONSEQUENTIAL, INCIDENTAL, SPECIAL OR INDIRECT DAMAGES ARISING OUT OF OR RELATED TO THIS AGREEMENT OR THE TRANSACTIONS CONTEMPLATED HEREUNDER, EVEN IF SELLER HAS BEEN APPRISED OF THE LIKELIHOOD OF SUCH DAMAGES.

14.2 LIMITATION OF LIABILITY. IN NO EVENT SHALL SELLER'S LIABILITY TO BUYER FOR BREACH OF THIS AGREEMENT EXCEED THE AGGREGATE PRICE OF THE PRODUCTS OR SERVICES PURCHASED BY BUYER HEREUNDER.

15. MERGER CLAUSE, ORAL STATEMENTS NOT BINDING

15.1 Seller's representatives may have made oral statements about the products subject to this agreement. Those statements are not warranties, should not be relied on by Buyer and are not part of the contract for sale. The entire contract is embodied in this writing. This writing constitutes the final expression of the parties' agreement, and it is a complete and exclusive statement of the terms of that agreement.

16. MISCELLANEOUS

16.1 Insolvency and Demands for Assurances. Except as may be prohibited by applicable law, Seller may cancel any unfilled order or obligation hereunder in the event one of the following occurs: (i) Buyer becomes insolvent or unable to pay its debts as they mature; (ii) voluntary or involuntary bankruptcy proceedings are instituted by or against Buyer; (iii) a receiver or trustee is appointed for the benefit of Buyer's creditors; (iv) an assignment is made for the benefit of Buyer's creditors; or (v) Buyer fails to provide an adequate written response within ten (10) days to a demand by Seller for assurance of Buyer's intention and ability to perform under any contract with Seller.

16.2 Indemnification. Seller makes no representations or promises concerning indemnification of Buyer or Buyer's agents except as set forth in this agreement.

16.3 Buyer's Breach. In the event that Buyer breaches this agreement, Buyer shall be liable to Seller for all direct and indirect damages, losses or injuries caused by such breach.

16.4 Seller's Quotation and Response to Specifications. Seller's quotation and response to Buyer's specifications, if applicable, shall be deemed to be incorporated herein by reference.

16.5 Force Majeure. Seller shall not be responsible, in any manner, for any failure or delay in the performance of any of its obligations hereunder caused by a strike, lockout or other industrial disturbance, act of public enemies, any government action, any civil or military action, insurrection, riot, landslide, hurricane, drought, fire, earthquake, explosion, flood, storm, act of God, or any other cause or event not reasonably within Seller's control.

16.6 Objection to Arbitration. Seller hereby objects to the submission to arbitration of any claims or disputes concerning this agreement.

16.7 Notices. Any required notices shall be given in writing at the address of each party or to such other address as either party may substitute by written notice to the other.

16.8 Assignment. Neither party may assign or transfer any of the rights, duties or obligations herein without the prior written consent of the other, and any purported attempt to do so shall be null and void.

16.9 Waiver. No waiver of any provision of this contract shall be effective unless made in writing. No waiver of any breach of any provision of this contract shall constitute a waiver of any subsequent breach of the same or any other provision of this contract.

16.10 Regulations Not Incorporated. No U.S. Government Procurement Regulations shall be included hereunder and binding on either party unless specifically agreed to in writing prior to incorporation herein.

16.11 Clerical Errors. Stenographical, typographical and clerical errors are subject to correction.

16.12 Compliance with Law. Unless otherwise agreed in writing, Buyer assumes all responsibility for obtaining any required export authorization, and Buyer agrees to indemnify Seller against any liability resulting from Buyer's non-compliance with such law. Buyer shall not export or re-export technical data products supplied by Seller, directly or through others, or the direct product of such data, to the prescribed countries listed in Section 379.4 and associated or successor sections of the U.S. Export Administration Regulations unless properly authorized by the U.S. Government. Buyer's indemnification obligations shall survive the termination of this agreement.

16.13 Governing Law. The validity, construction, performance, and enforcement of this agreement shall be governed by the substantive laws of the State of Maryland. The parties consent to the jurisdiction of the courts of the State of Maryland and agree that venue for any lawsuit shall be Howard County, Maryland.

16.14 Attorney's Fees. The prevailing party in any legal action brought by one party against the other shall be entitled, in addition to any other rights and remedies it may have, to reimbursement for its expenses incurred thereby, including court costs and reasonable attorney's fees.

16.15 Severability. The provisions of this agreement are severable and if any one or more such provisions are judicially determined to be illegal or otherwise unenforceable, in whole or in part, the remaining provisions or portions of this agreement shall nevertheless be binding on and enforceable by and between the parties hereto.

16.16 Entire Agreement. These Terms and Conditions constitute the entire agreement between the parties and supersede all prior agreements and understandings between them relating to the subject matter hereunder, and no modification of this agreement shall be binding on either party unless it is in writing and signed by both parties.